

This guide is for informational purposes only. Omniwash UK makes no warranties or guarantees, express, implied or statutory, as to the information in this document.



# SPARE PARTS

---

**UNDERCOUNTER GLASS/DISHWASHERS  
OMPD500SD/OMPD500ABSD/  
OMPG500S/OMPG500SD**

**Omniwash UK  
Tel: 020 8813 6616 Fax: 020 8813 5515  
Email: [sales@omniwash.co.uk](mailto:sales@omniwash.co.uk)**

This guide is for informational purposes only. Omniwash UK makes no warranties or guarantees, express, implied or statutory, as to the information in this document.



Item No.	Product Code	Description
1	CETP25G01	On/off button, round, grey
2	CEGV6	Lens, green, 6mm
3	CETP25GPC	Cycle start button, round, grey
4	CEGA6	Lens, orange, 6mm
5	CETP25GLV	Cycle selector button, round, grey
6	CETP6GR	Cap, warning light, grey
7	CETP25GRF	Cold rinse button, round, grey
8	CETP25GRR	Re-set button, round, grey
9	CETP25GPS	Drain pump button, round, grey
10	CETP25GRRS	Heater indicator button, round, grey
11	CETP25SF	Support for indicator button
12	CETP25GR	Button, round, grey (cap)
13	CEPC5D25RGR	Control panel, plastic, grey
13A	CEPC5D25QGR	Control panel, plastic, grey
13B	CEPC5D25DPGR	Control panel, plastic, grey, double skin

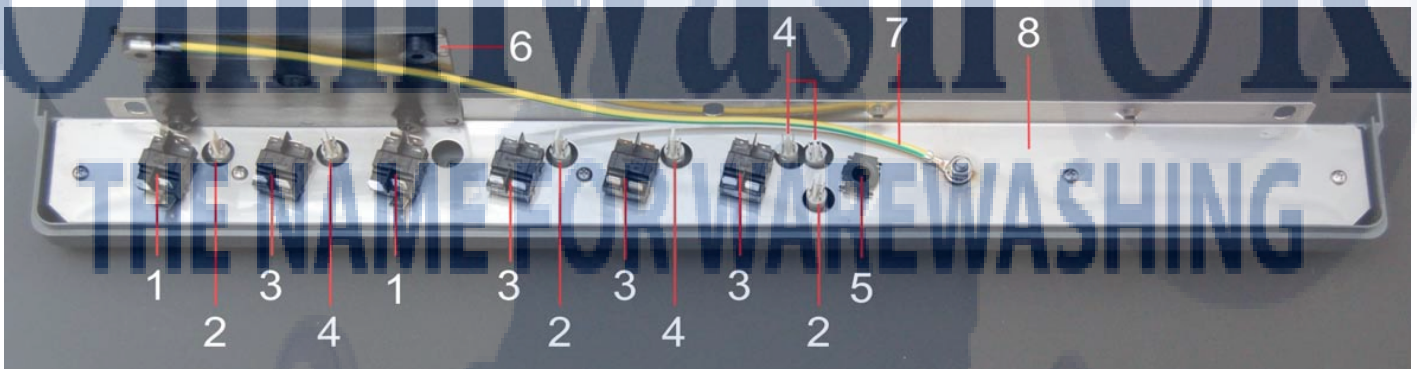

Item No.	Product Code	Description
1	CEDPPFD	Inner switch bipolar
2	CESPV6	Lamp assy, green, 6mm
3	CEBPFD	Inner push button bipolar
4	CESPA6	Lamp assy, orange, 6mm
5	CETP25SF	Support for indicator button
6	CEPPPC	Extension for component tray
7	CECBCTTC	Catenary, loom, ground
8	GMPI5D25	Steel inner control panel

This guide is for informational purposes only. Omniwash UK makes no warranties or guarantees, express, implied or statutory, as to the information in this document.



Item No.	Product Code	Description
1	CEPC5D25	Control panel, plastic, blue
2	CETP25V01	On/off button, round, green
3	CETP25APC	Cycle start button, round, orange
4	CETP25ALV	Cycle selector button, round, orange
5	CETP25VRF	Cold rinse button, round, green
6	CETP25AR	Re-set button, round, orange
7	CETP25APS	Drain button, round, orange
8	CETP25BR	Heater indicator button, round, blue
9	CEGV6	Lens, green, 6mm diameter
10	CEGA6	Lens, orange, 6mm diameter
11	CETP6B	Cap, warning light, blue, 6mm diameter
12	CETP25B	Button, round, blue (cap)

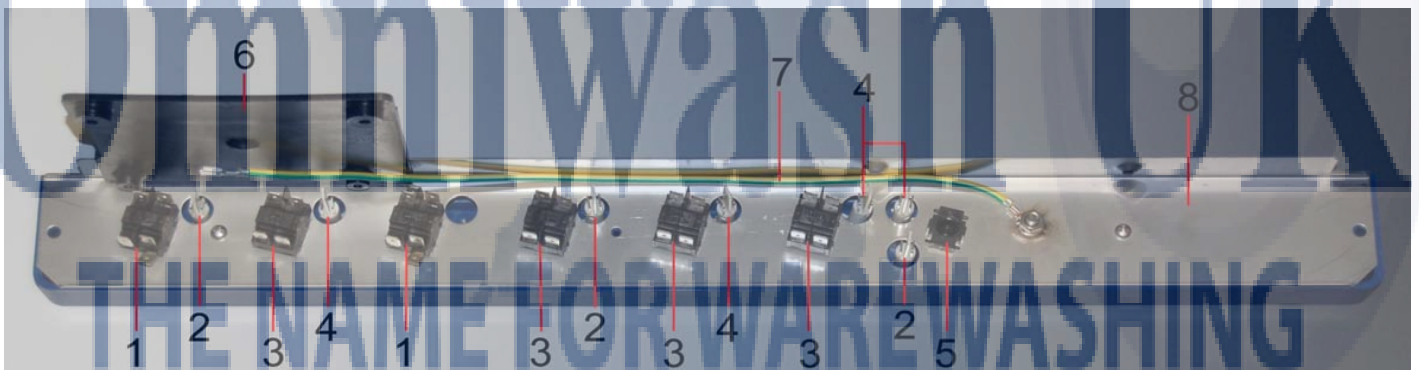

Item No.	Product Code	Description
1	CEDPPFD	Latched push switch
2	CESPV6	Lamp, green, 6mm diameter
3	CEPBPFDD	Momentary push switch
4	CESPA6	Lamp, orange, 6mm diameter
5	CETP25SF	Support for blanking button
6	CEPPPC	Extension plate
7	CECBCTTC	Earth cable
8	GMPI5D25	Steel control panel

This guide is for informational purposes only. Omniwash UK makes no warranties or guarantees, express, implied or statutory, as to the information in this document.

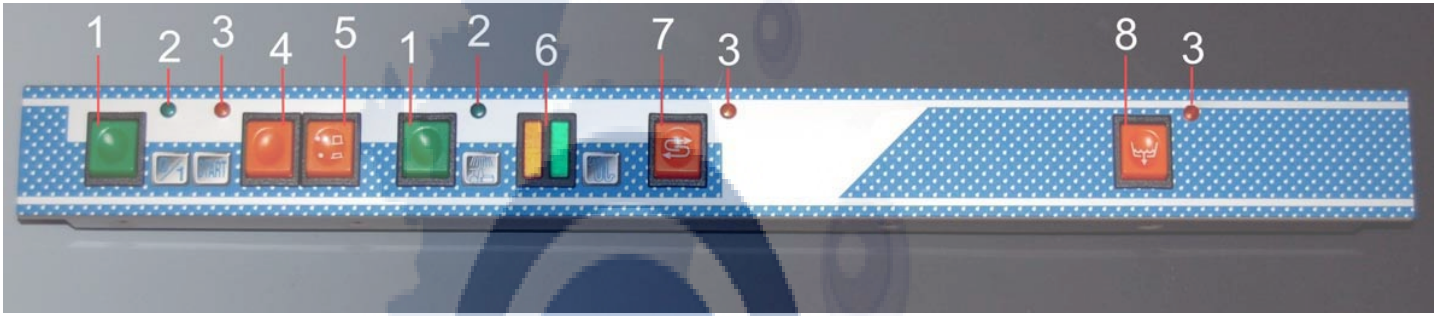

Item No.	Product Code	Description
1	CETRP2230V	Push button green
2	CEGV6	Lens green, 6mm
3	CEGA6	Lens orange, 6mm
4	CETRP2230A	Push button orange
5	CETRP2230ALV	Speed selector orange button
6	CESDAV	Double warning light, orange/green
7	CETRP2230AR	Push button orange "water softener"
8	CETRP2230APS	Push button orange "drain pump"

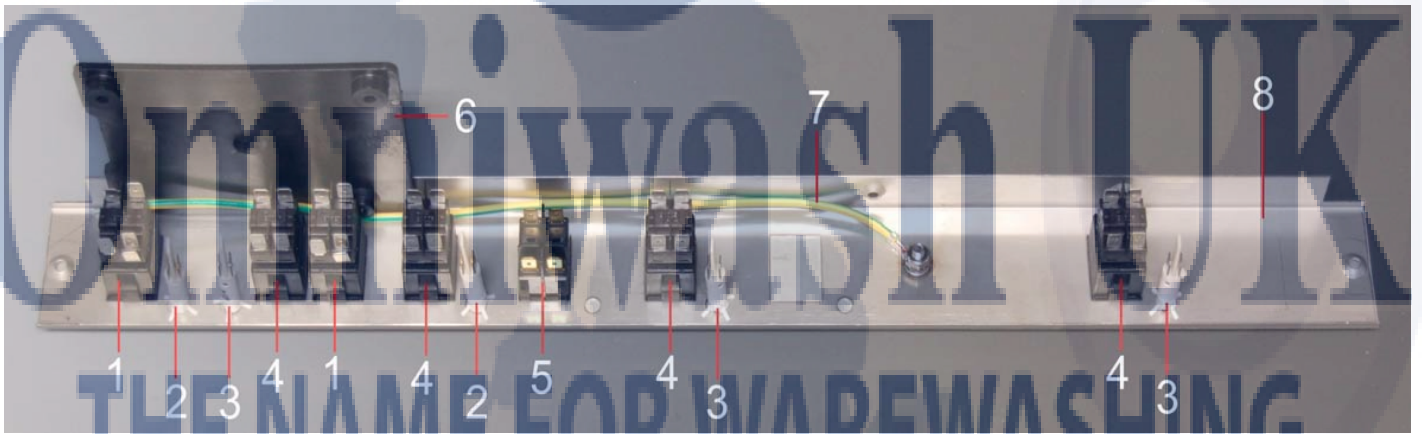

Item No.	Product Code	Description
1	CEDPPFDCOMP	Inner switch body complete
2	CESPV6	Lamp assy, green, 6mm
3	CESPA6	Lamp assy, orange, 6mm
4	CEBPFFDCOMP	Inner push button body complete
5	CESDAV	Double warning light
6	CEPPPC	Extension for component tray
7	CECBCTTC	Catenary loom ground
8	GMPI5CF	Steen inner control panel

This guide is for informational purposes only. Omniwash UK makes no warranties or guarantees, express, implied or statutory, as to the information in this document.

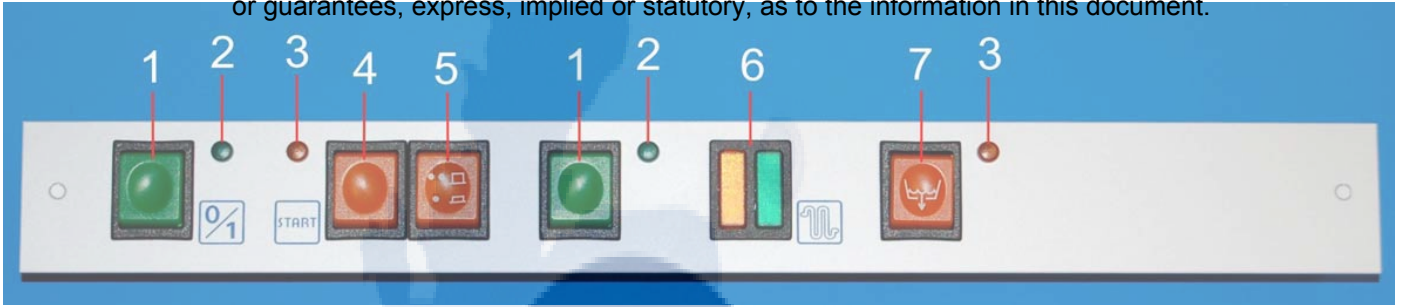

Item No.	Product Code	Description
1	CETRP2230V	Push button green
2	CEGV6	Lens green, 6mm
3	CEGA6	Lens orange, 6mm
4	CETRP2230A	Push button orange
5	CETRP2230ALV	Speed selector button
6	CESDAV	Double warning light, orange/green
7	CETRP2230APS	Push button "drain pump", orange



Item No.	Product Code	Description
1	CEDPPFDCOMP	Inner switch body complete
2	CESPV6	Lamp assy, green, 6mm
3	CESPA6	Lamp assy, orange, 6mm
4	CEPBPFDCOMP	Push button innerbody complete
5	CESDAV	Double warning light, orange/green
6	GMPI4QC	Steel inner control panel

This guide is for informational purposes only. Omniwash UK makes no warranties or guarantees, express, implied or statutory, as to the information in this document.

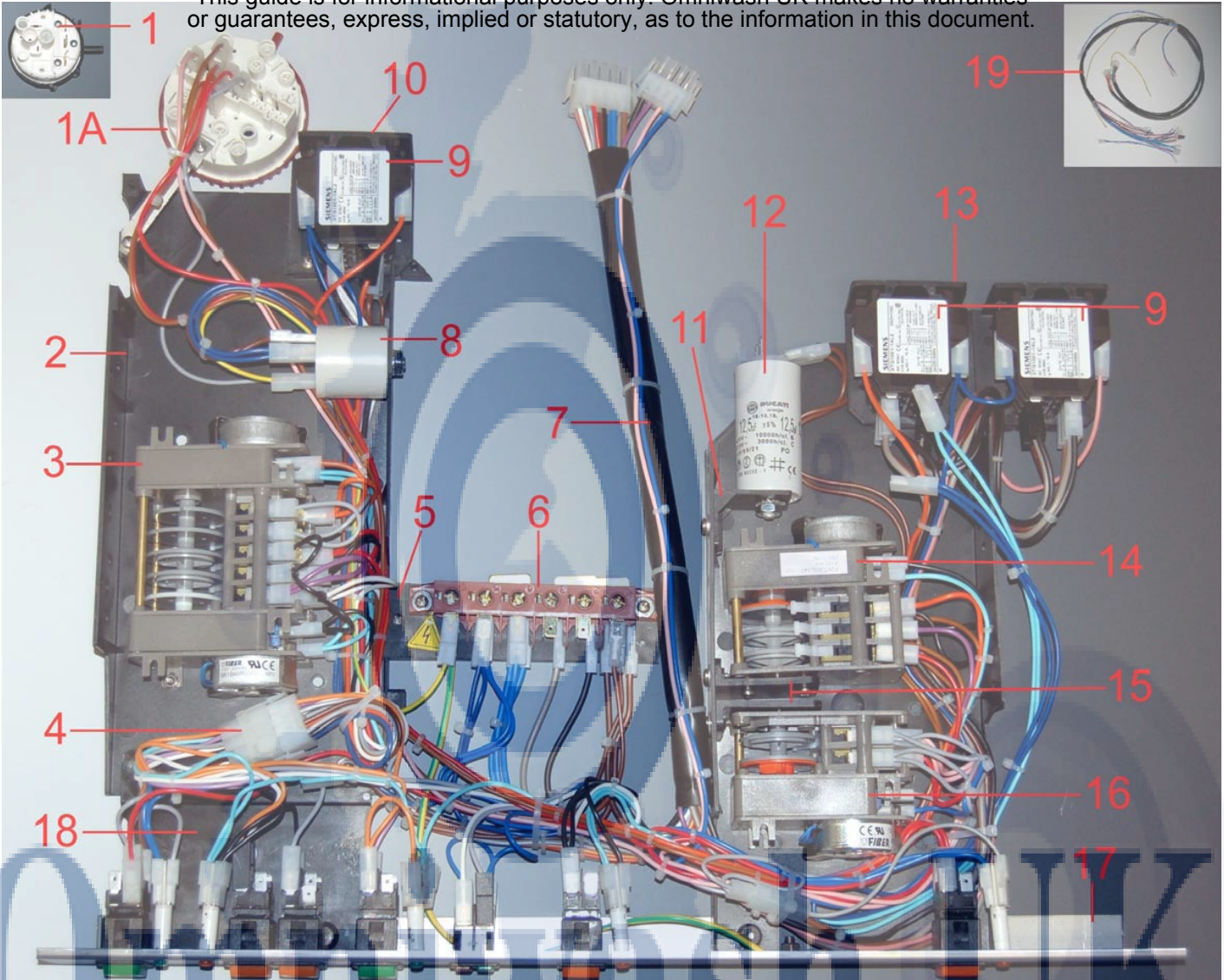

Item No.	Product Code	Description
1	CEPRE	Pressure switch
1A	CEPRE2LUL	Double air pressure switch
2	CEPCE	Component tray
3	CETD1224B	Timer, two cycles
4	CECBPC2V4	Control panel wiring loom
5	CEPFM	Mounting plate for terminal block
6	CEM0S3F	Main terminal block, 6-way
7	CECBS2T482	Upper loom
8	CEFA	Suppressor
9	CECTF	4-p contactor
10	AM05SQTL1	Contactor bracket
11	AM05SQFC	Contactor bracket
12	CECN12	Capacitor 12.5 mf
13	AM05SQTL2	Double contactor bracket
14	CETR20B	Salt regeneration timer
15	CEPFTSIM	Timer mounting bracket
16	CEPSTFB	Drain pump timer
17	GMPI5CF	Steel control panel
18	CEPPPC	Extension for component tray
19	CECBI482	Lower loom

This guide is for informational purposes only. Omniwash UK makes no warranties or guarantees, express, implied or statutory, as to the information in this document.

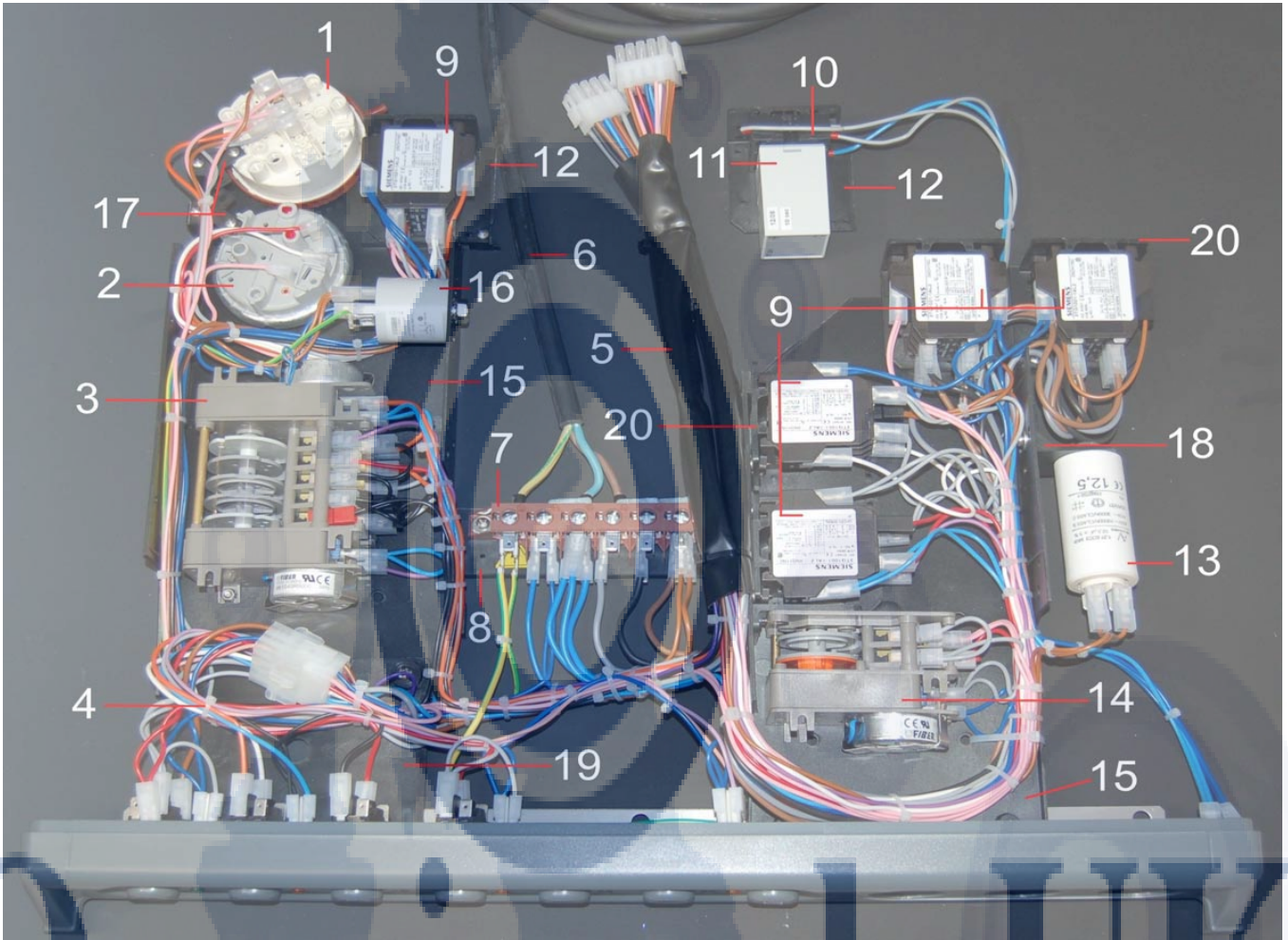

Item No.	Product Code	Description
1	CEPRE2LUL	Double pressure switch
2	CEPR62P	Pressure switch, 30/90
3	CETD1224BGB	Timer, 2-min & 4-min, ABS version
4	CECBPC2V4GBABPS	Control panel wiring loom, ABS version
5	CECBS2T482GBABPS	Upper loom, ABS version
6	CECE3536	Main supply cable 3x6mm
7	CEMOS3F	Main terminal block, 6-way
8	CEPFM	Extension plate for terminal block
9	CECTF	4-pole contactor
10	CETF60A	Base for Delay timer
11	CETF024	Delay timer
12	AM05SQTL1	Bracket for delay timer
13	CECN12	Capacitor 12.5 mi-F
14	CEPSTFB	Drain timer, 180" 220V
15	CEPCE	Component tray, no components
16	CEFA	Suppressor
17	AM0SQPR	Bracket for pressure switch
18	AM05SQFC	Bracket for capacitor
19	CEPPP	Extension for component tray
20	AM05SQTL2	Double contactor bracket

This guide is for informational purposes only. Omniwash UK makes no warranties or guarantees, express, implied or statutory, as to the information in this document.

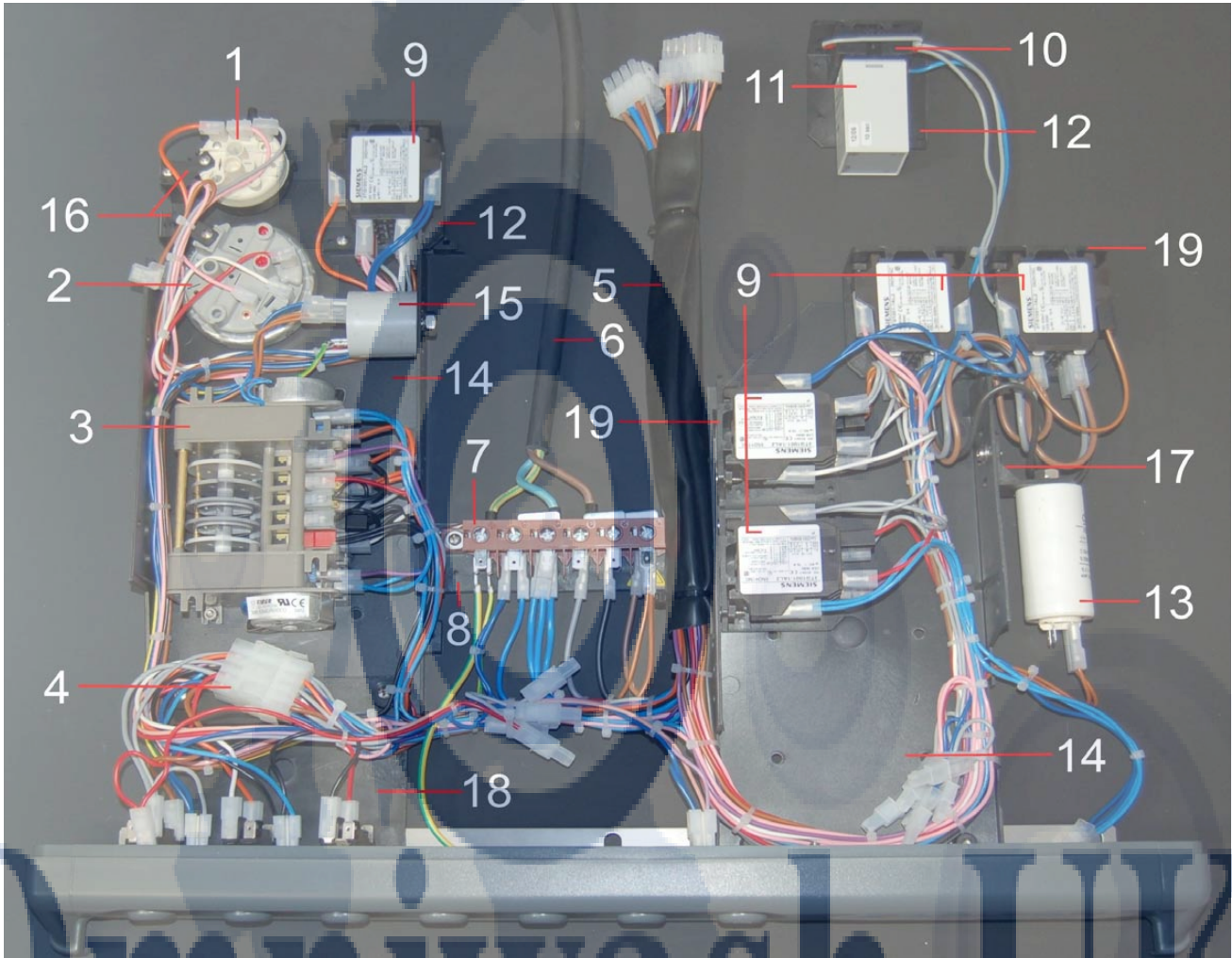

Item No.	Product Code	Description
1	CEPRE	Pressure switch, standard
2	CEPR62P	Pressure switch, 30/90
3	CETD1224BGB	Timer, 2-min & 4-min
4	CECBPC2V4GBABPS	Control panel wiring loom
5	CECBS2T482GBABPS	Upper loom
6	CECE3536	Main supply cable 3x6mm
7	CEMOS3F	Main terminal block, 6-way
8	CEPFM	Extension plate for terminal block
9	CECTF	4-pole contactor
10	CETF60A	Base for Delay timer
11	CETF024	Delay timer Air Break system
12	AM05SRTL1	Bracket for delay timer
13	CECN12	Capacitor 12.5 mF
14	CEPCE	Component tray, no components
15	CEFA	Suppressor
16	AM0SQPR	Bracket for pressure switch
17	AM05SQFC	Bracket for capacitor
18	CEPPPC	Extension for component tray
19	AM05SRTL2	Double contactor bracket



This guide is for informational purposes only. Omniwash UK makes no warranties or guarantees, express, implied or statutory, as to the information in this document.

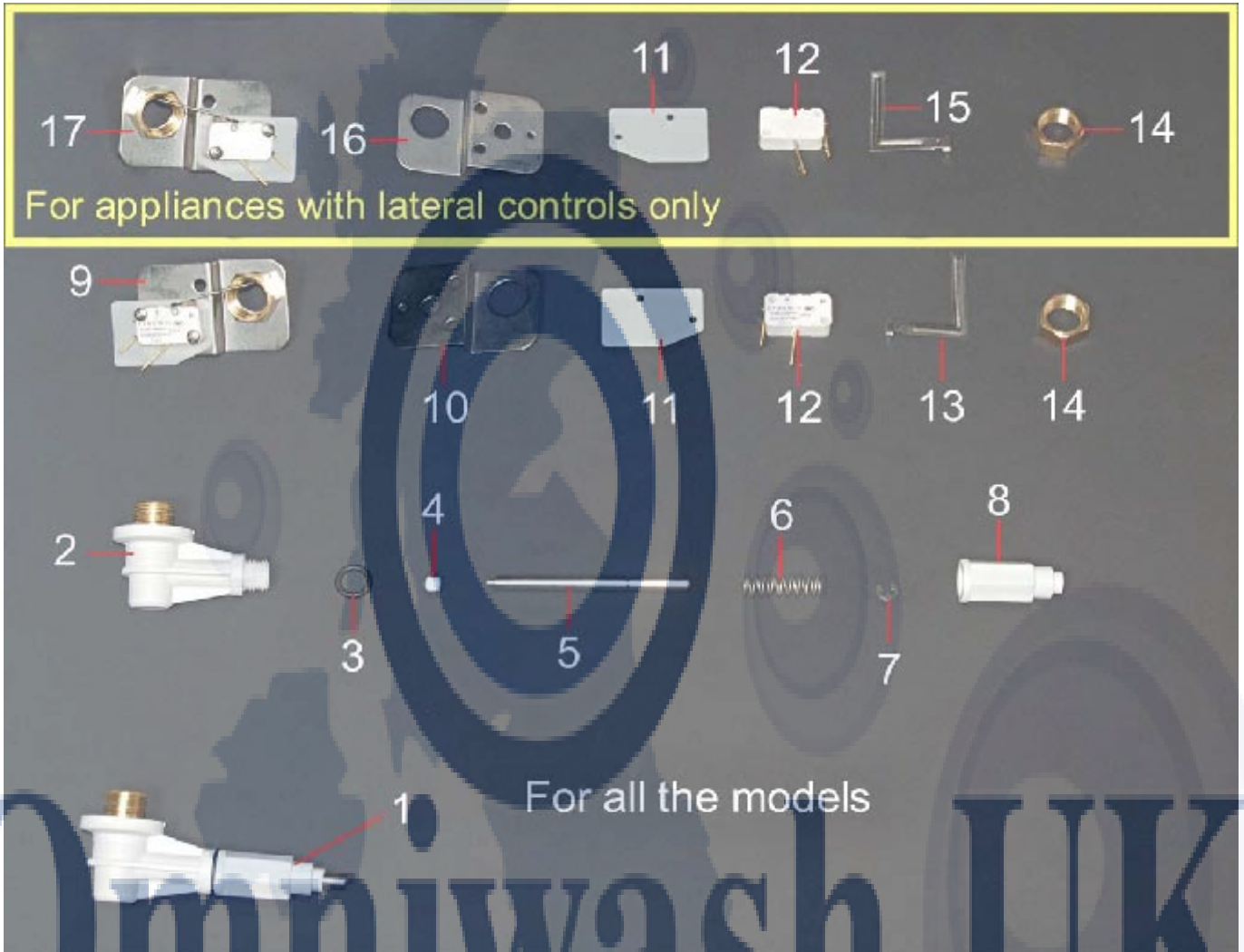

Item No.	Product Code	Description
1	CEMP1823B	Door plunger assembly
2	CEMP18B	Door plunger elbow
3	OR112	O ring 112
4	CEMPPIB	Push rod end cap
5	CEMP21	Push rod
6	CEMP20	Door plunger spring
7	CEMP22	Circlip
8	CEMP23B	Door plunger body
9	CEMP12CSC	Door switch assy complete
10	CEMP13CS	Bracket for door switch
11	CEISOMPNT	Insulating plate
12	CEMP12SM	Door micro switch only
13	CEMP12ACS	Operating arm, right angles
14	D038A	Brass lock nut 3/8"
15	CEMP12ACL	Operating arm, right angles, lateral
16	CEMP13CL	Bracket for door switch, lateral
17	CEMP12CLC	Door switch assy complete, lateral

This guide is for informational purposes only. Omniwash UK makes no warranties or guarantees, express, implied or statutory, as to the information in this document.



Item No.	Product Code	Description
1	GB4821F	Boiler monophase
2	CESB454	Rinse safety thermal switch
3	GB08V0	Rinse element guard, large
4	GB09V9	Securing nut, rinse element guard
5	CERB30	Rinse element 3kw
5A	CERB22	Rinse element 2.2kw
6	G42303S	Rinse element seal, small
7	CETB85	Adjustable control thermostat
8	CETV55	Fixed wash control thermostat
9	CEMTB	Thermostat knob
10	CEPRTV0	Thermostat protection
11	CERV25	Wash element 2.5kw
11A	CERV22	Wash element 2.2kw
12	ORRV	O-ring, wash element
13	VRP12I	Flat washer 12mm diameter
14	VDRV	Lock nut
15	CEPRVV0	Guard, wash element

This guide is for informational purposes only. Omniwash UK makes no warranties or guarantees, express, implied or statutory, as to the information in this document.

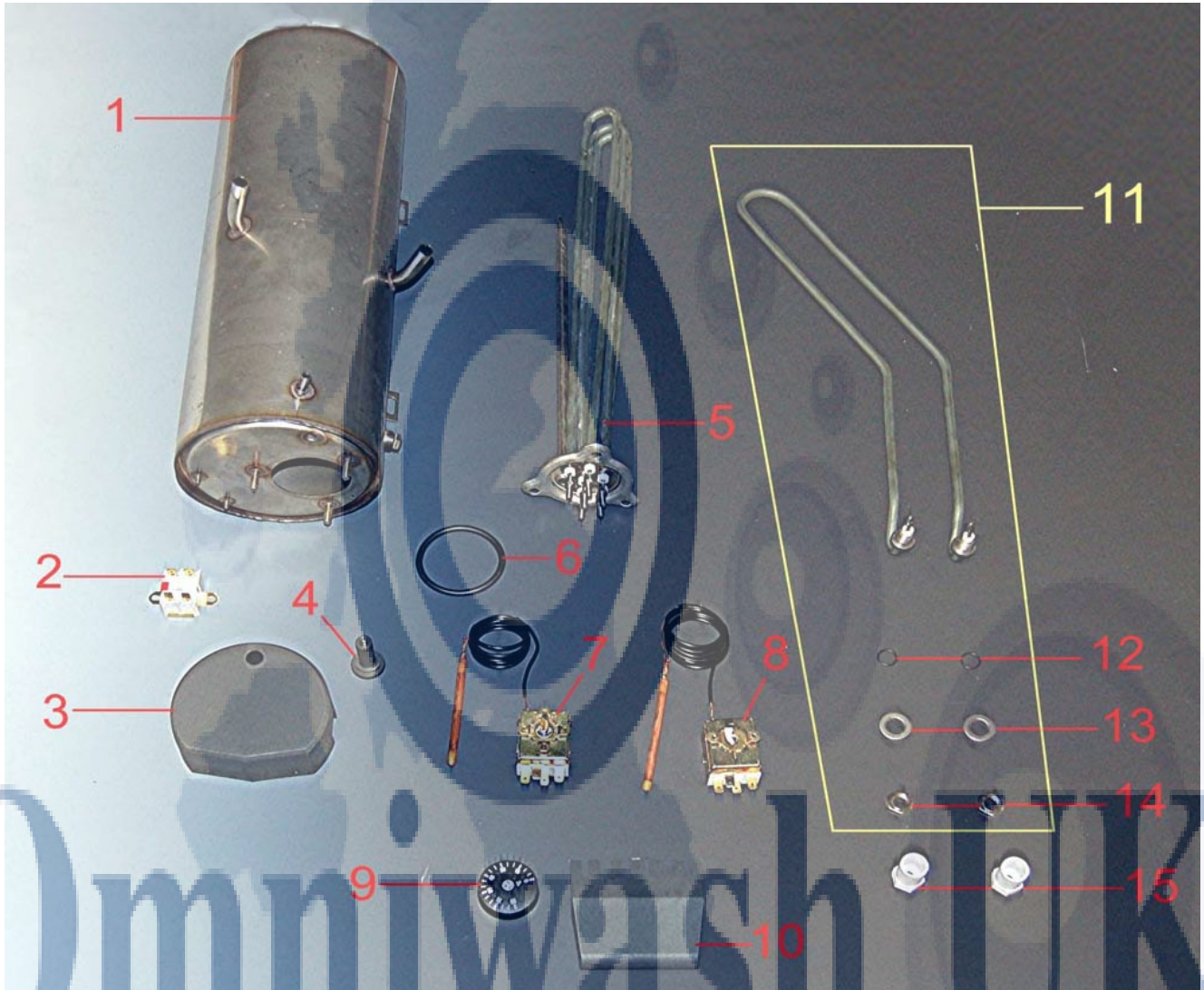

Item No.	Product Code	Description
1	GB4823F	Boiler, 3ph
2	CESB454	Rinse safety thermal switch
3	GB083FV0	Rinse element guard, large
4	GB093FV0	Retaining nut, rinse element, lsrge
5	CERB603F	Rinse element, 6kw, 3ph
6	ORRV3F	Or boiler element
7	CETB85	Adjustable control thermostat, boiler
8	CETV55	Fixed wash control thermostat
9	CEMTB	Thermostat knob
10	CEPRTV0	Guard thermostat
11	CERV25	Wash element 2.5kw
12	ORRV	O-ring, wash element
13	VRP12I	Flat washer 12mm diameter
14	VDRV	Lock nut
15	CEPRVV0	Guard, wash element

This guide is for informational purposes only. Omniwash UK makes no warranties or guarantees, express, implied or statutory, as to the information in this document.

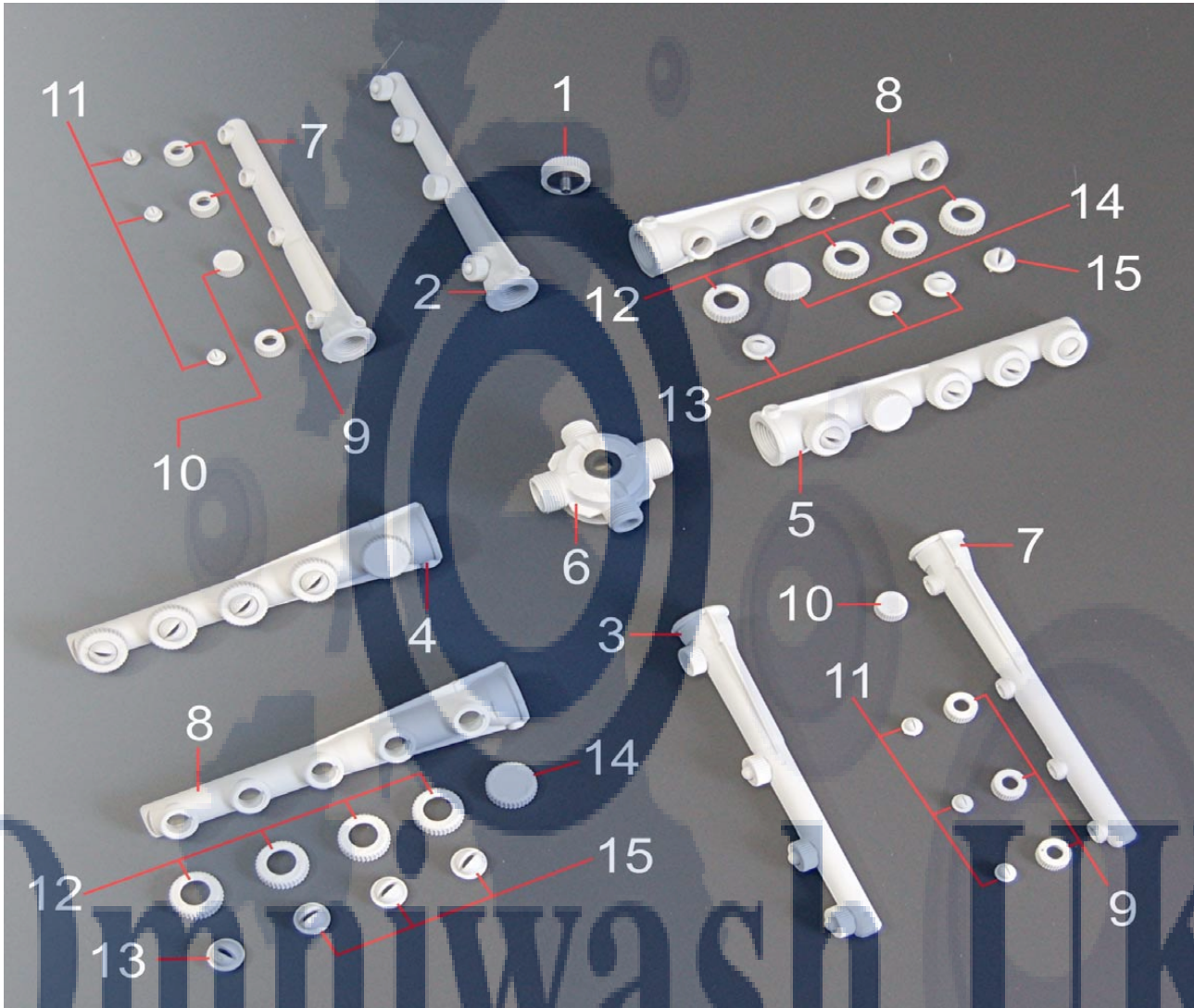

Item No.	Product Code	Description
1	LS09PB	Spindle retaining screw
2	LSI46CSB	Rinse arm, LH, complete
3	LSI46CDB	Rinse arm, RH, complete
4	LSI46BSB	Wash arm, LH, complete
5	LSI46BDB	Wash arm, RH, complete
6	LSI0607AB	Centre boss complete with bushes
7	LSI46CB	Rinse arm only
8	LSI46BB	Wash arm only
9	LSI021B	Rinse jet retaining ring
10	LSI022B	Rinse arm blank
11	LSI020B	Rinse jet
12	LSI017B	Wash jet ring nut
13	LSI015B	Wash jet, RH marked D
14	LSI018B	Wash arm blank
15	LSI016B	Wash jet, LH, marked S
16	LSI46BBB	Rotating assy complete

This guide is for informational purposes only. Omniwash UK makes no warranties or guarantees, express, implied or statutory, as to the information in this document.

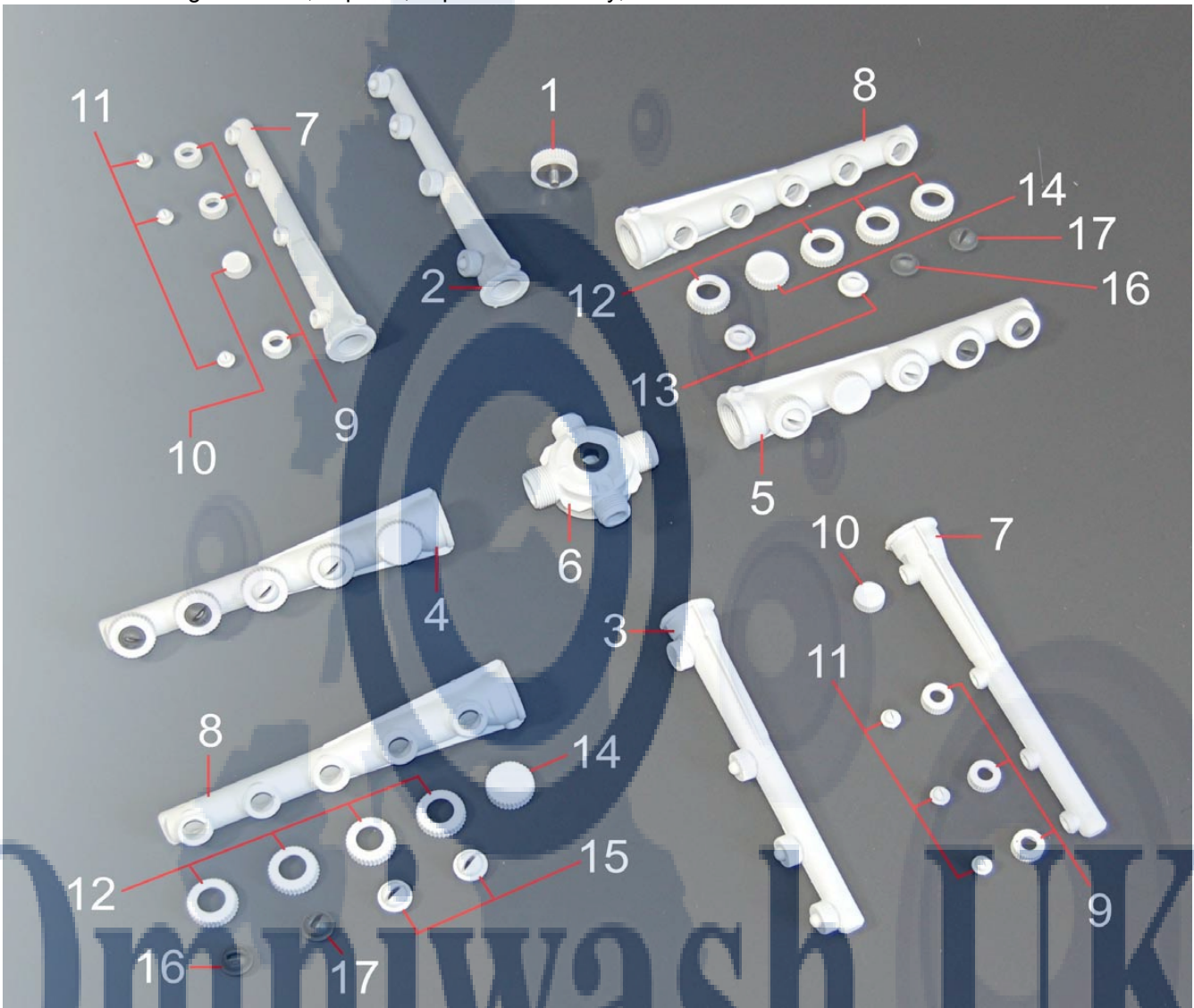

Item No.	Product Code	Description
1	LS09PB	Spindle retaining screw
2	LSI46CSB	Rinse arm, LH, complete
3	LSI46CDB	Rinse arm, RH, complete
4	LSI46BSBDS	Wash arm, LH, complete
5	LSI46BDBDS	Wash arm, RH, complete
6	LSI0607AB	Centre boss complete with bushes
7	LSI46CB	Rinse arm only
8	LSI46BB	Wash arm only
9	LSI021B	Rinse jet retaining ring
10	LSI022B	Rinse arm blanking cover
11	LSI020B	Rinse jet
12	LSI017B	Wash jet ring nut
13	LSI015B	Wash jet, RH marked D
14	LSI018B	Wash arm blanking cover
15	LSI016B	Wash jet, LH, marked S
16	LSI015GSP	Special wash jet. Grey, LH marked D
17	LSI016GSP	Special wash jet. Grey, LH marked S
18	LSI146BBBDS	Rotating assembly complete

This guide is for informational purposes only. Omniwash UK makes no warranties or guarantees, express, implied or statutory, as to the information in this document.

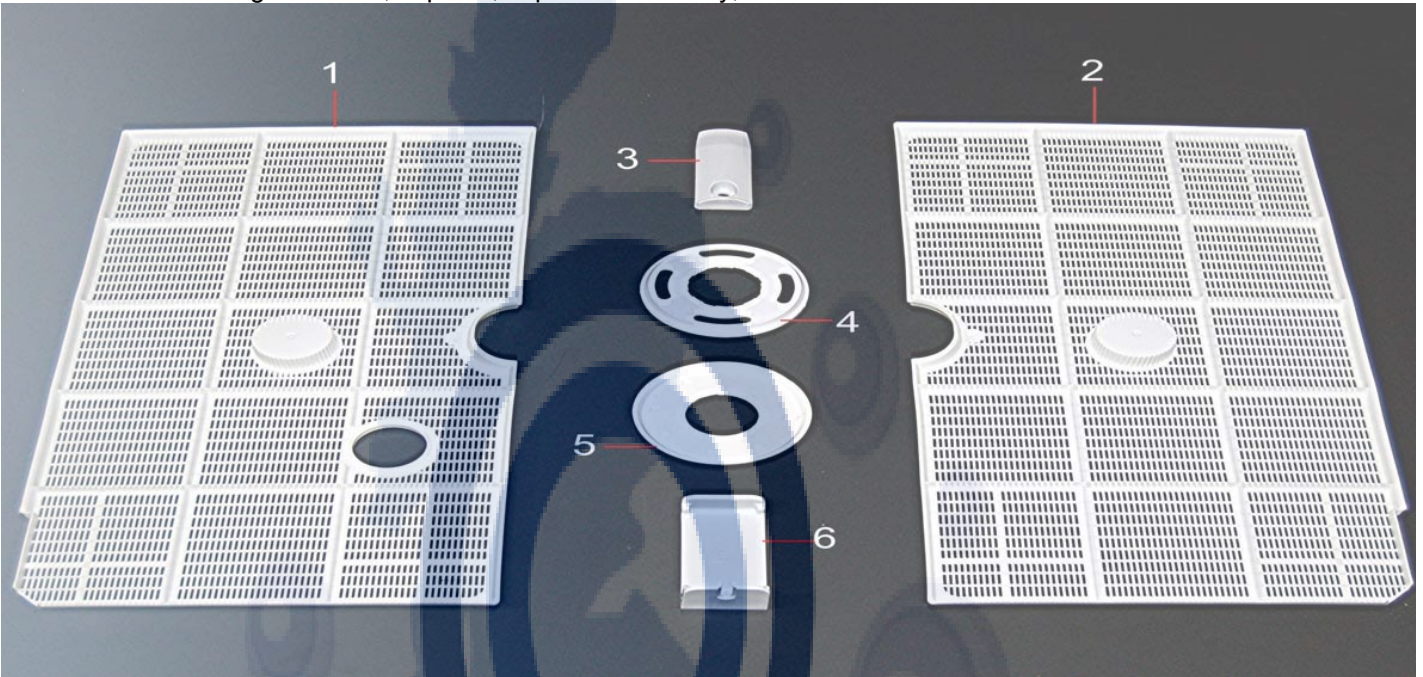

Item No.	Product Code	Description
1	LIF4V2PSX04	Top filter section, LH, with hole
2	LIF4V2PDX04	Top filter section, RH, no hole
3	AM0APF4B	Rear filter support
4	LI034P2F04	Filter support disk, with slots
5	LI034PV0	Deflector disk
6	AM0AAF4B	Front filter support

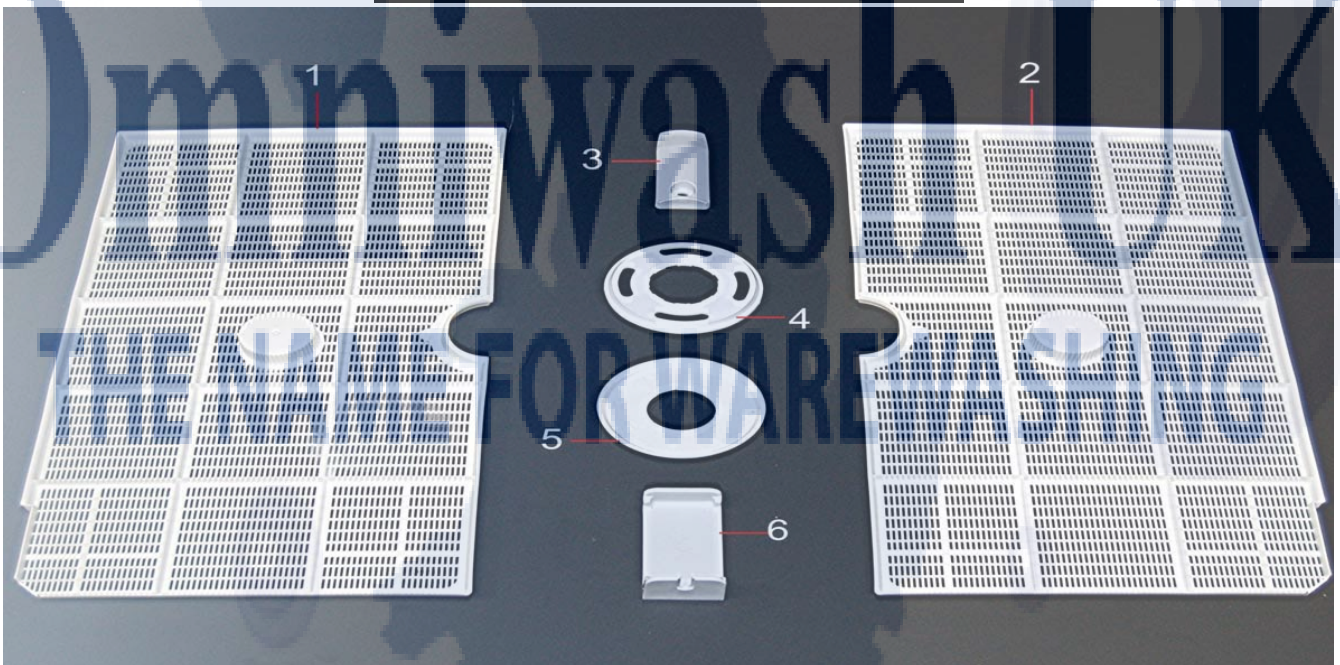

Item No.	Product Code	Description
1	LIF4V2PCSX04	Top filter section, LH, no hole
2	LIF4V2PDX04	Top filter section, RH, no hole
3	AM0APF4B	Rear filter support
4	LI034P2F04	Filter support disk, with slots
5	LI034PV0	Deflector disk
6	AM0AAF4B	Front filter support

This guide is for informational purposes only. Omniwash UK makes no warranties or guarantees, express, implied or statutory, as to the information in this document.

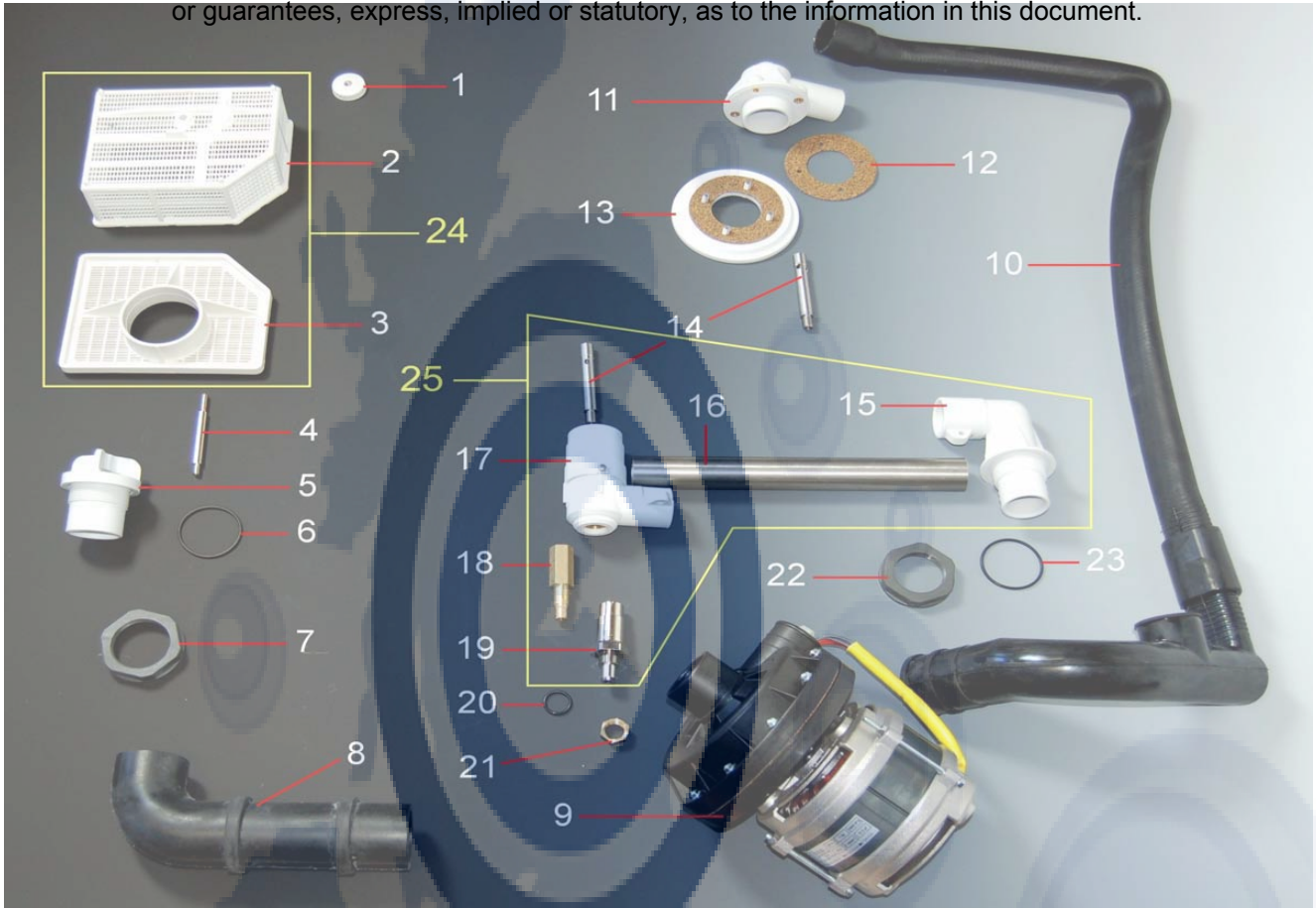

Item No.	Product Code	Description
1	GA013B	Filter retaining nut
2	GA315RV0	Wash filter upper body
3	GA315RAV0	Wash filter base
4	GA61220T	Filter spindle
5	GA311B	Filter boss
6	OR3187	O-ring 3187
7	DP112	Plastic nut 1.5"
8	GA538	Wash inlet hose
9	EP100	Washpump, 1.0 hp
10	GLMSIC404	Wash outlet hose
11	LS5B	Top boss
12	LS02	Cork seal
13	LS03PC	Baffle plate
14	LS08	Wash spindle
15	LA430FCB	Wash inlet elbow
16	LI428	Spacer tube
17	LI029CAB	Bottom boss assembly
18	LI330	Spindle extension
19	LI533FOT	Support for bottom boss
20	OR122	O-ring 122
21	D038A	Brass lock nut 3/8"
22	DP114	Plastic nut 1.5"
23	OR3181	O-ring 3181
24	GA315RCB	Plastic filter, complete
25	GLICQ482BCOMP	Lower elbow and boss assembly complete

This guide is for informational purposes only. Omniwash UK makes no warranties or guarantees, express, implied or statutory, as to the information in this document.

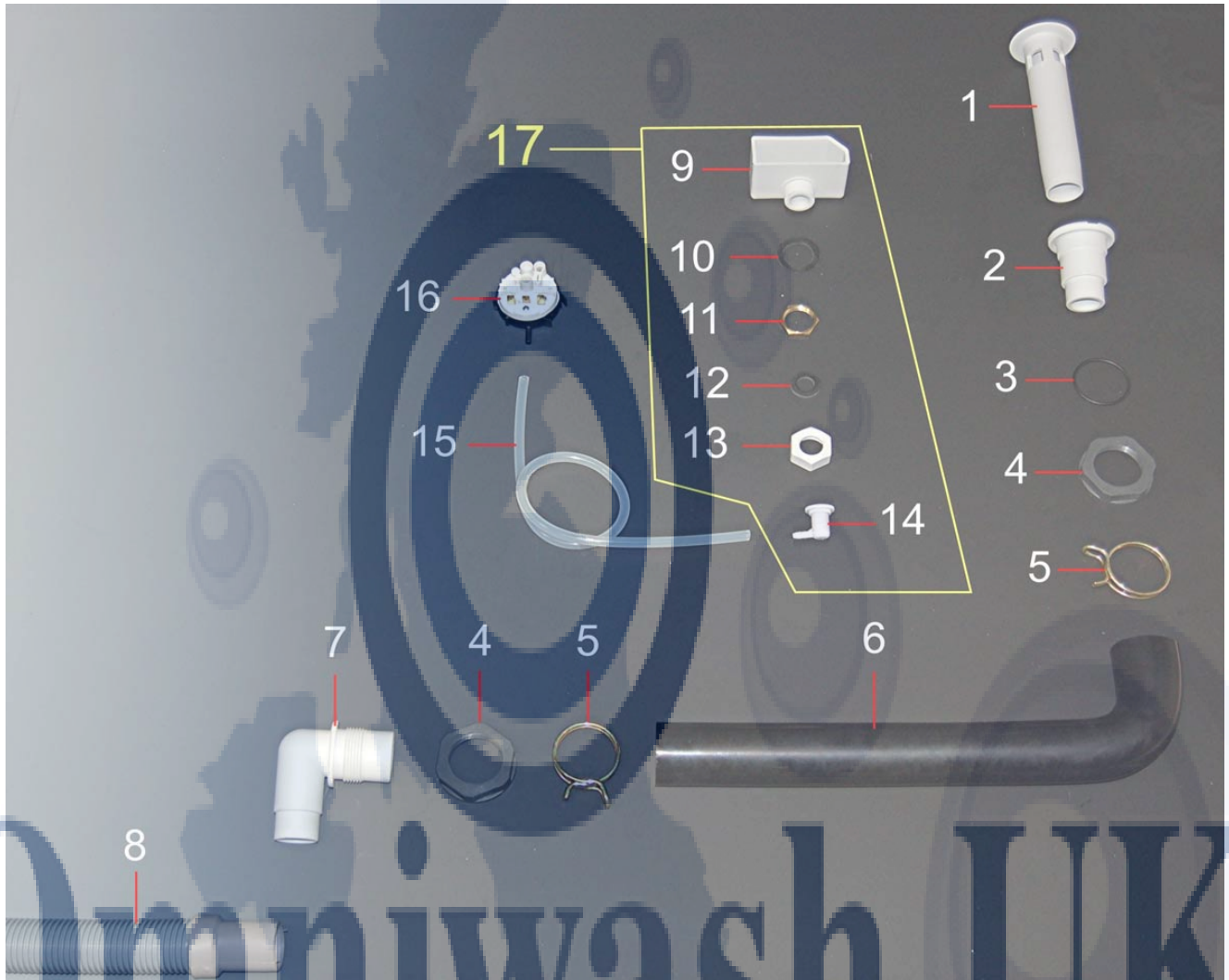

Item No.	Product Code	Description
1	GS416CCAB	Drain plug or standpipe
2	GS317B	Drain outlet boss
3	OR3168	O-ring
4	DP114	Plastic nut
5	FAM4050	Spring clip
6	GS520	Drain hose
7	GS321B	Drain outlet elbow
8	GS330	Waste outlet hose (gravity)
9	GP025B	Air trap
10	G382615G	Airtrap seal
11	D034	Brass nut, 3/4
12	G251525G	Sealing washer
13	GP026BB	Airtrap elbow nut, white
14	GP026AB	Airtrap elbow, white
15	TSIL48	Silicon tube 4/8mm
16	CEPRE	Pressure switch
17	GP025BCOMP	Air trap assembly, complete



This guide is for informational purposes only. Omniwash UK makes no warranties or guarantees, express, implied or statutory, as to the information in this document.

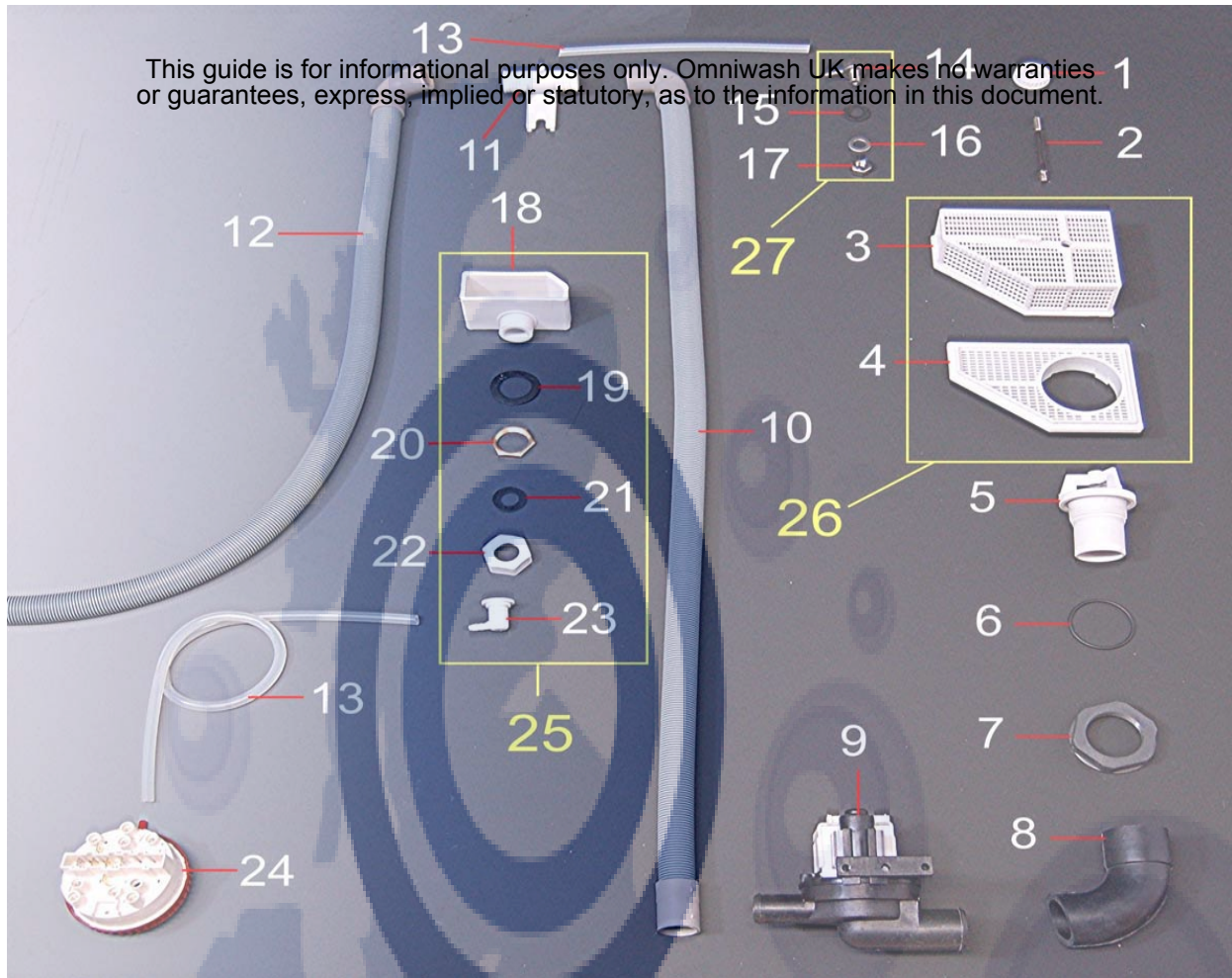

Item No.	Product Code	Description
1	GA013B	Filter retaining nut
2	GAGS599	Filter spindle
3	GA115RV0	Upper body, drain filter
4	GA115RABV0	Base, Drain filter
5	GA111TB	Drain filter boss
6	OR3168	O-ring 3168
7	DP114	Plastic nut 1.1/4"
8	GA18PS5USA	Drain pump inlet hose
9	CEPS5	Drain pump
10	GSTS820PS	Internal drain hose
11	CAPSVSF	Drain non return valve
12	GSTS2500PS	External drain outlet hose
13	TSIL48	Silicone tube
14	GSDETPI10	Connection elbow, steel
15	G24112	Seal, 24x11x2
16	VRP10I	Plain washer, 10mm diameter
17	VD10I	Nut, m10
18	GP025B	Pressure vessel only
19	G382615G	Seal 38x26x1.5
20	D034	Brass nut, 3/4
21	G251525G	Sealing washer
22	GP026BB	Air tap elbow nut
23	GP026AB	Air trap elbow
24	CEPRE2LUL	Double air pressure switch
25	GP025BCOMP	Pressure vessel assembly complete
26	GA115SCOMP	Drain filter top and base complete
27	GSDETPI10COMP	Conn'n elbow, steel, complete assembly

This guide is for informational purposes only. Omniwash UK makes no warranties or guarantees, express, implied or statutory, as to the information in this document.

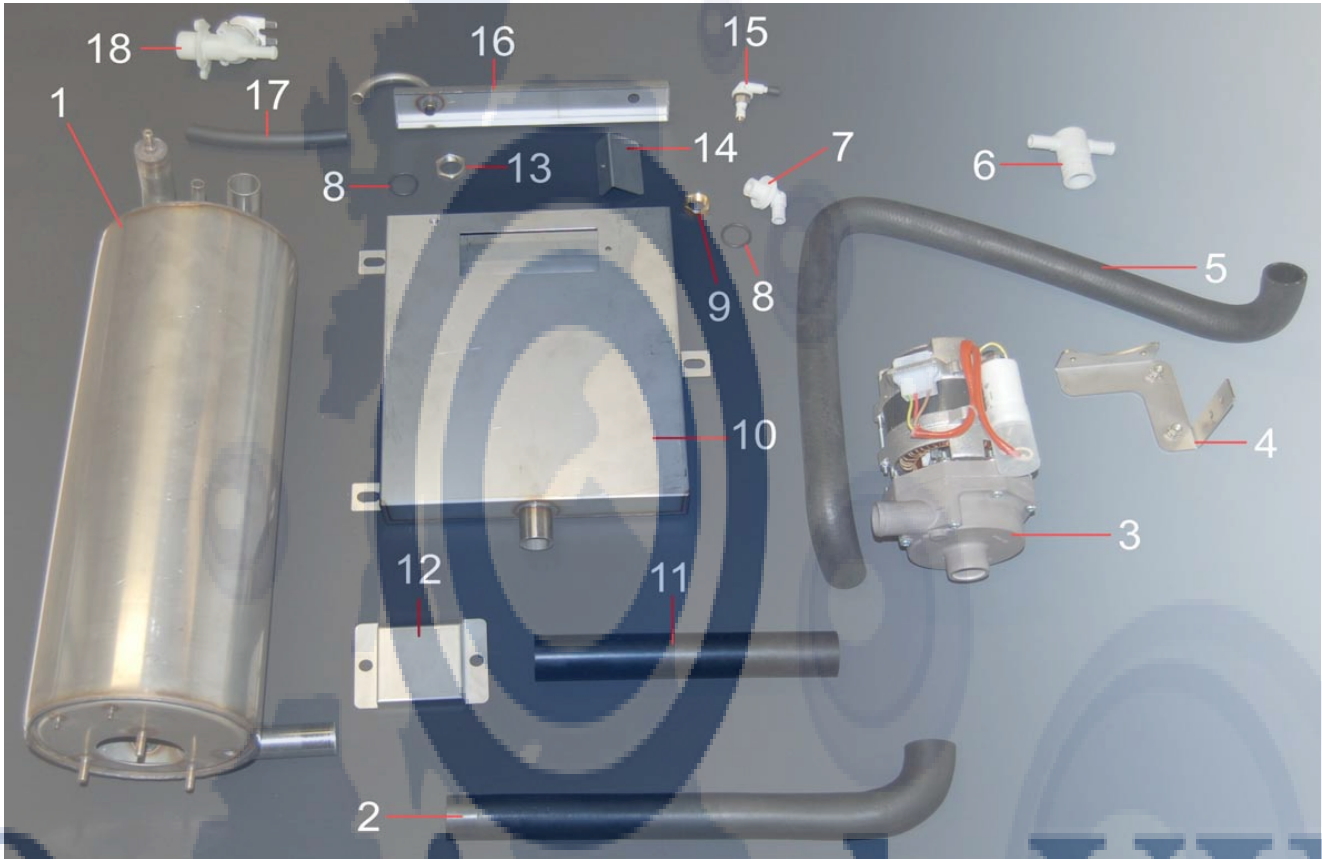

Item No.	Product Code	Description
1	GB4823FAB	Boiler, 3-ph, ABS version
2	GAMA4AB	Rinse pump inlet hose, ABS
3	ABPRF5213	Rinse pump, ABD
4	ABSTFP5213	Mounting bracket for rinse pump, ABS
5	GRMP4AB	Rinse pump outlet hose, ABS
6	ARBRTRP	Tee connector, ABS
7	GRS06B	Inlet elbow
8	OR128	O-ring 128
9	D038A	Brass lock nut 3/8"
10	ABSB46	ABS tank, Steel
11	ABMSB4	ABS tank exit hose
12	ABDFIV	Protection plate for ABS wash tank
13	ABDFSB	Nut, Steel, M20 x 1
14	ABDFISB	Deflector plate for ABS tank
15	DSDET040BC	Soap elbow assembly
16	ABCSB	Top cover for ABS tank
17	TG1118WRC	Internal supply tube, 11x18
18	CEEV1	Solenoid valve, 1-way

This guide is for informational purposes only. Omniwash UK makes no warranties or guarantees, express, implied or statutory, as to the information in this document.

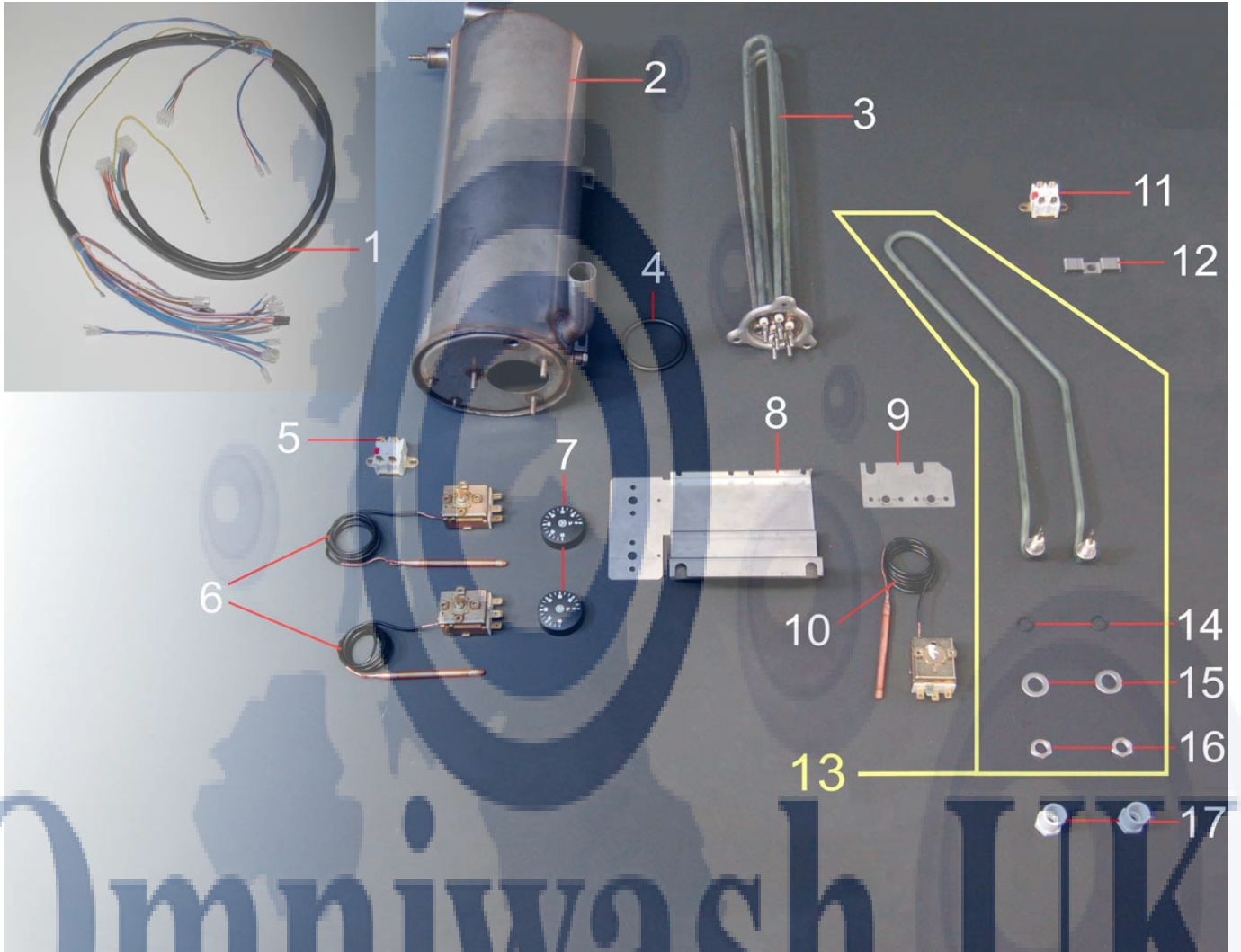

Item No.	Product Code	Description
1	CECBI482AB	Lower wiring loom, Air Break
2	GB4823FAB	Boiler, 3-ph, Air Break System version
3	CERB603F	Rinse element 6 kW
4	ORRB3F	O-ring for rinse element
5	CESB454	Safety switch, boiler
6	CETB85	Boiler control thermostat
7	CEMTB	Thermostat knob
8	AM0SQFTDE46AB	Bracket for chemical pumps
9	AM0SQTB	Bracket for thermostats
10	CETV55	Fixed wash control thermostat
11	CESV001	Safety switch, wash tank
12	AM0SQFRV4	Retaining clip for wash element
13	CERV25	Wash element complete, 2.5kW
14	ORRV	O-rings for wash element
15	VRP12I	Washer for wash element, 12mm diameter
16	VDRV	Nut for wash element
17	CAPRV	Protection for wash element

This guide is for informational purposes only. Omniwash UK makes no warranties or guarantees, express, implied or statutory, as to the information in this document.

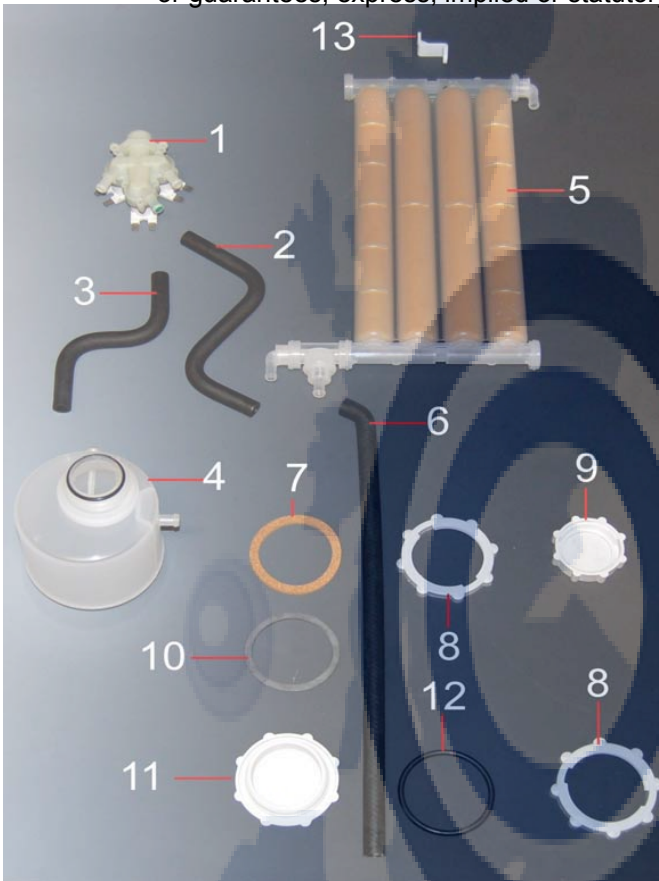

Basket: 35x35cm & 40x40cm

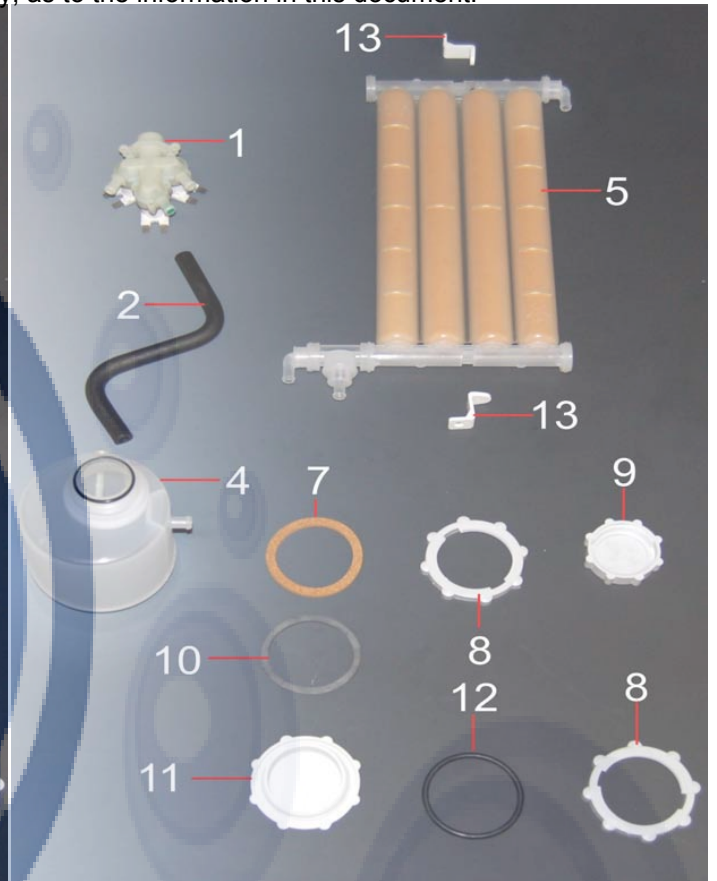

Basket: 50x50cm

Item No.	Product Code	Description
1	CEEV3	Solenoid valve, 3-way - 220v
2	DS327	Injector operating hose, big
3	DS227	Injector operating hose, small
4	CERI43	Salt chamber
5	CERI47	Water softener
6	GB6TEB	Moulded feed tube
7	CERI44GS	Cork seal washer for salt chamber
8	CERI45	Lock nut for salt chamber
9	CERI46	Cap, thick, salt chamber
10	CERI44	Seal washer for salt chamber
11	CERI50NTB	Cap, thin, salt chamber
12	OR6275	O-ring
13	AM0PFD	Retaining clip

This guide is for informational purposes only. Omniwash UK makes no warranties or guarantees, express, implied or statutory, as to the information in this document.

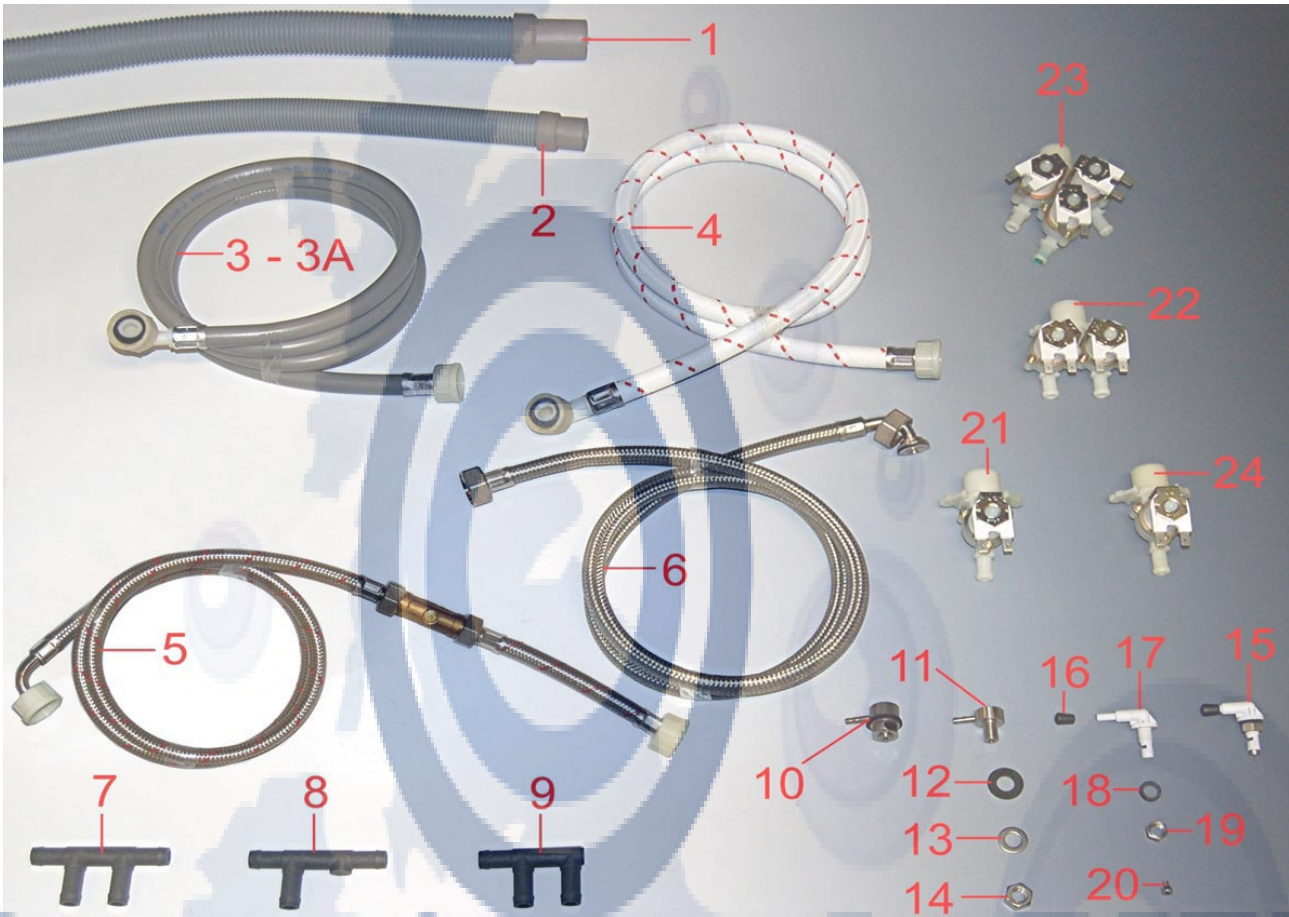

Item No.	Product Code	Description
1	GS330	Drain Pipe diameter 31.5
2	GS130	Drain pipe diameter 25
3	TC34	Inlet Water Pipe 2m
3A	TC3415	Water Supply Hose, 3/4 Bsp mt 1.5
4	TC3415GBWRC	Water Supply Hose, 3/4 Bsp "wrc" mt 1.5
5	VDCVGB	Double check valve with tube
6	TC3420USA	Water supply hose, 3/4 Bsp "Fda"
7	GB055	Double Tee Connector
8	GB017	Tee connector
9	GB017NT	3-Way Connector
10	GSDETPI10COMP	Soap Inlet Elbow Assembly
11	GSDETPI10	Soap inlet elbow
12	G24112	Washer 24x11x2
13	VRP10I	Washer diameter 10
14	VD10I	Nut hex mt 10
15	DSDET040BC	Soap elbow assembly
16	DSDET043B	Soap injector cap
17	DSDET040B	Soap injector
18	G15101G	Sealing washer
19	VD10IP1	Nut
20	VVEI46I	Blanking screw mt 4x6
21	CEEV1	Solenoid Valve, 1-way
22	CEEV2	Solenoid Valve, 2-way
23	CEEV3	Solenoid Valve, 3-way
24	CEEV124	Single solenoid Valve C/W 24v Coil

This guide is for informational purposes only. Omniwash UK makes no warranties or guarantees, express, implied or statutory, as to the information in this document.



Item No.	Product Code	Description
1	VVTE580Z	Special screw for motor assembly, 5x80
2	VR51	Special tab washer
3	VD51	Special hexagon nut
4	VVTE570Z	Special screw for motor assembly, 5x70
5	EP05M5	Motor endplate NDE
6	EP011	Bearing ring
7	EP07	Motor bearing
8	EP7589	Rotor
9	EP7510	Stator
10	EP05	Motor endplate DE
11	VVTE512I	Special screw
12	EP755TP	Impellor back plate
13	EP04	Rotating shaft seal
14	EP752NT	Cork gasket
15	EP753	Impellor
16	EP751TP	Impellor housing, open nipple
17	VATE4232Z	Special screw
18	EP751TPC	Impellor housing, closed nipple
19	EP100	Wash pump complete, open nipple
19A	EP100C	Wash pump complete, closed nipple

This guide is for informational purposes only. Omniwash UK makes no warranties or guarantees, express, implied or statutory, as to the information in this document.

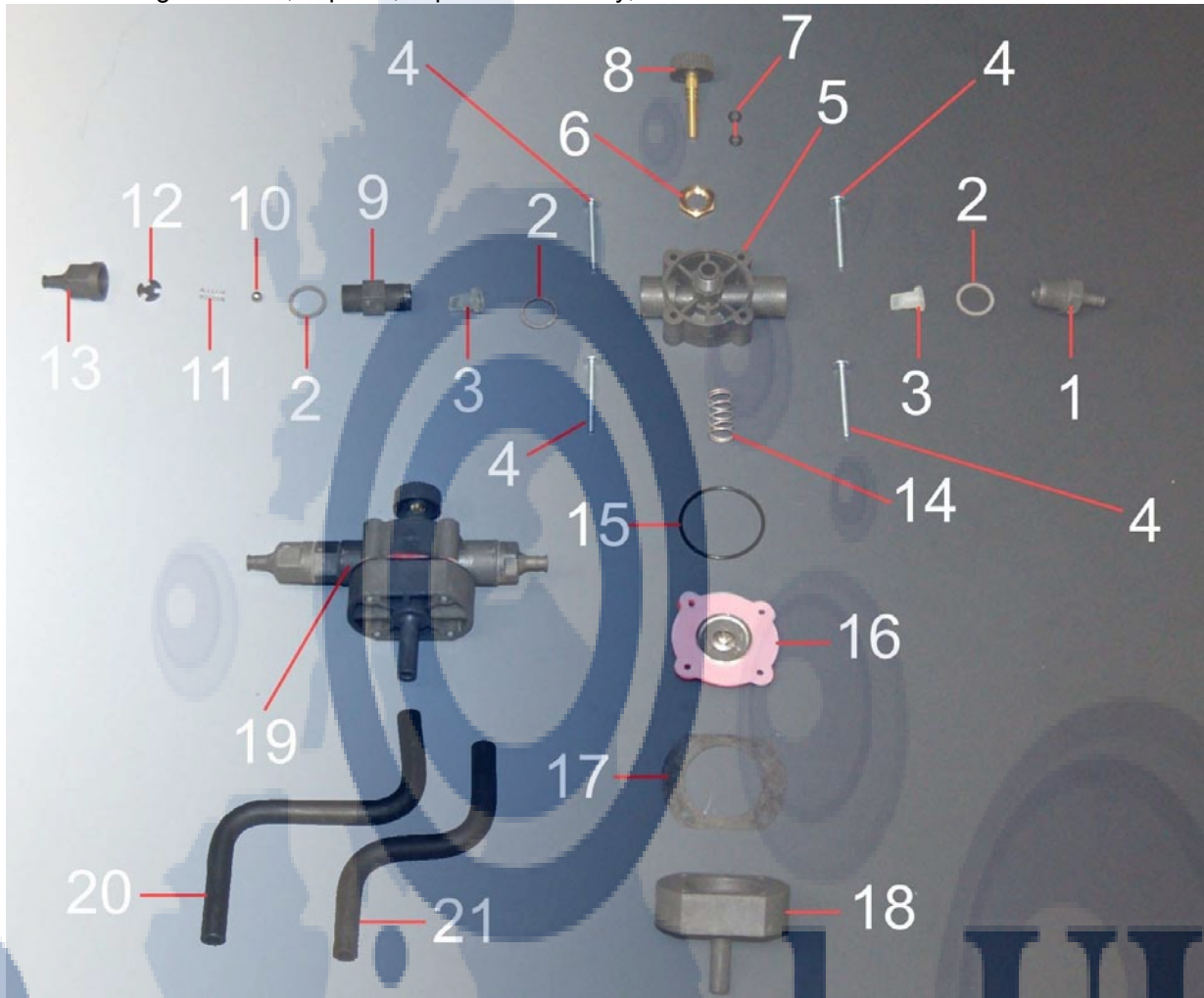

Item No.	Product Code	Description
1	DS10NT	Inlet nipple
2	G16221F	Seal for injector
3	DS8S	Non return valve, rubber
4	VVTCC445Z	Special screw
5	DS3	Injector front body
6	DS24	Brass nut 20x4x14
7	OR103	O ring 103
8	DS1	Injector adjustable screw
9	DSVNR12	Housing for non return valve
10	DSVNR13	1/4" ball for non return valve
11	DSVNR14	Spring for non return valve
12	DSVNR16	Special disk for non return valve
13	DSVNR17NT	Outlet nipple
14	DS4	Spring for diaphragm's injector
15	OR422	O-ring 42x2
16	DS06M3	Diaphragm
17	DS15	Seal 64x50x1 for diaphragm
18	DS15A	Injector rear body
19	DSAM3NT	Rinse aid injector
20	DS327	Tube, dispenser, big pump
21	DS227	Tube, dispenser, small pump

This guide is for informational purposes only. Omniwash UK makes no warranties or guarantees, express, implied or statutory, as to the information in this document.



Item No.	Product Code	Description
1	D0STSILSKC	Peristaltic rinse aid tube with fittings
2	D0SPRRSKC	Rotating pump head, rinse aid
3	TG510DS	Rinse aid tube to boiler
4	D0SVNRSKC	Non return valve
5	D0SBRIETLE	Pump housing
6	FAM710	Wire clip for tube
7	TSIL48	Silicone rinse aid inlet tube
8	D0SVFFSK	Foot valve with filter



This guide is for informational purposes only. Omniwash UK makes no warranties or guarantees, express, implied or statutory, as to the information in this document.



Item No.	Product Code	Description
1	D0STSANSKC	Peristaltic soap tube with fittings
2	D0SPRRSKC	Rotating pump head, soap
3	D0SDETETLE	Pump housing
4	FAM710	Spring clip for tubing
5	TC58	Soap PVC tubing
6	D0SVFFSK	Foot valve with filter

This guide is for informational purposes only. Omniwash UK makes no warranties or guarantees, express, implied or statutory, as to the information in this document.

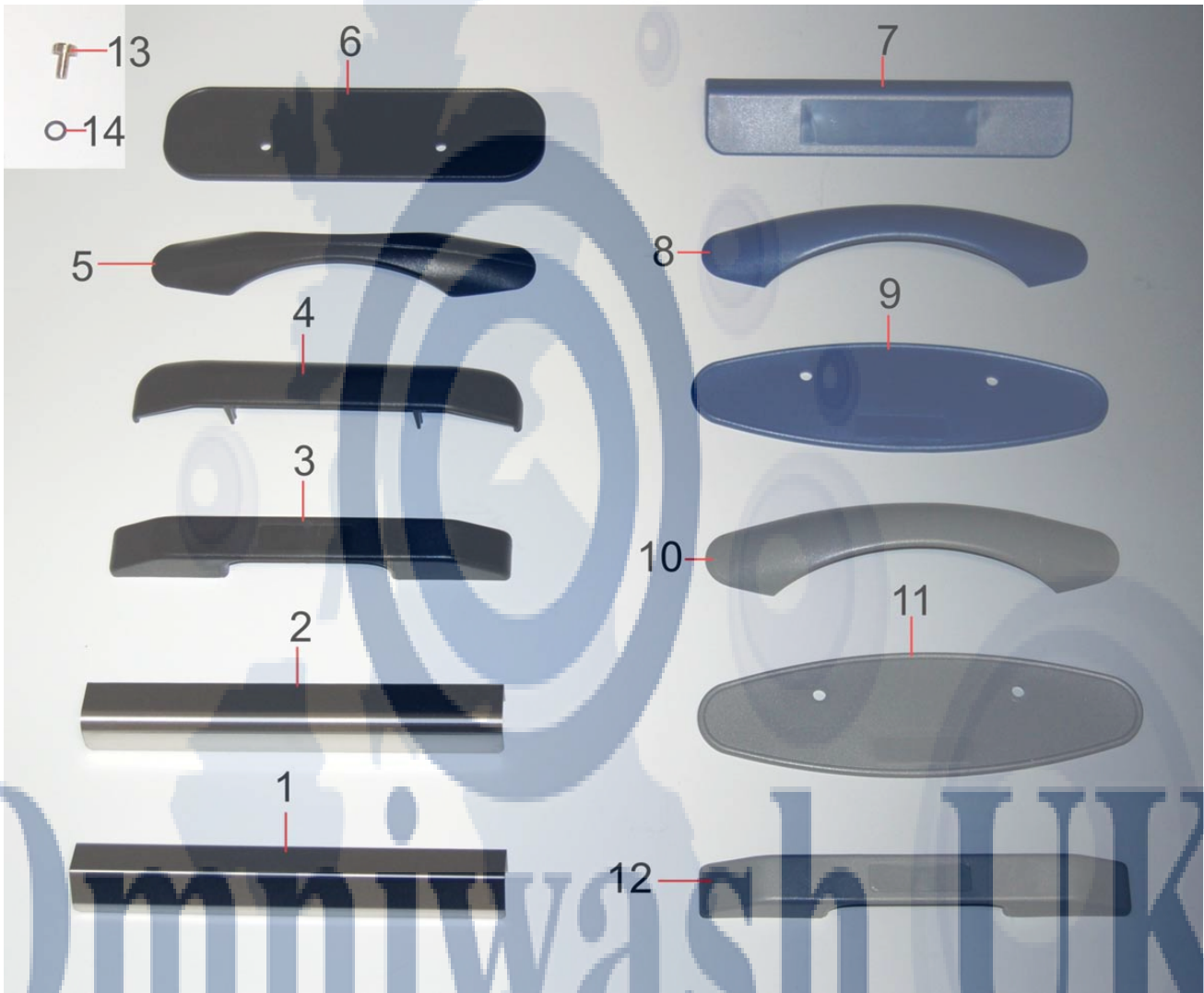

Item No.	Product Code	Description
1	AM010R	Handle, Stainless steel, angled section
2	AM010F	Handle, Stainless steel, round section
3	AM010PA	Handle, black, thru grip, angled
4	AM010PC	Handle, black, closed grip, curved
5	AM010SW	Handle, black, thru grip, double curved
6	AM010SMH	Handle backplate, rectangular
7	AM010SIM	Handle, blue, closed grip, rectangular
8	AM010MD25	Handle, blue, thru grip, oval
9	AM010CD25	Handle backplate, blue, oval
10	AM010MD25GR	Handle, grey, thru grip, oval
11	AM010CD25GR	Handle backplate, grey, oval
12	AM010PAGR	Handle, grey thru grip, angled
13	VVSP6100	Screw, door handle fixing
14	OR106	O-ring, screw, door handle

This guide is for informational purposes only. Omniwash UK makes no warranties or guarantees, express, implied or statutory, as to the information in this document.

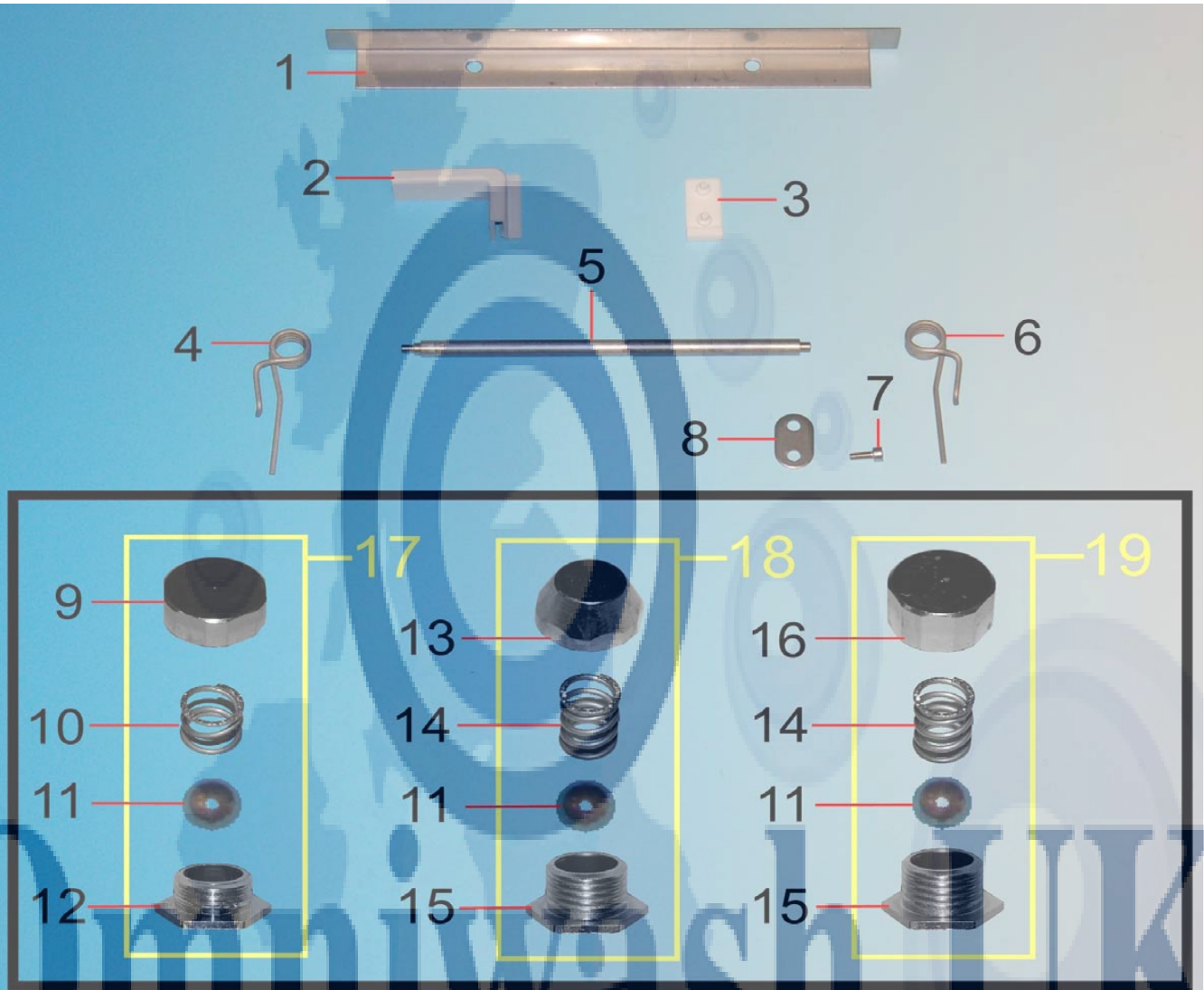

Item No.	Product Code	Description
1	GMDP2	Door deflector 40x40*50x50
2	AM014B	Plastic corner guard
3	AMPCP	Door stop
4	AMMP24DX	Door spring, rh model 50x50
5	AM412NTM	Door pin spacer model 50x50
6	AMMP24SX	Door spring, lh model 50x50
7	VVEI410I	Screw m4x10
8	AM0PFPPM	Pin security plate
9	AM011ANT	Ball catch nut
10	AM011CNT	Ball catch spring
11	AM011D	Ball catch ball
12	AM011ENT	Door ball catch seat
13	AM011AR	Ball catch nut
14	AM011C	Ball catch spring
15	AM011E	Ball catch seat
16	AM011A	Ball catch nut
17	AM011NT	Door ball catch assembly, double skin
18	AM011R	Door ball catch assembly
19	AM011	Door ball catch assembly

This guide is for informational purposes only. Omniwash UK makes no warranties or guarantees, express, implied or statutory, as to the information in this document.

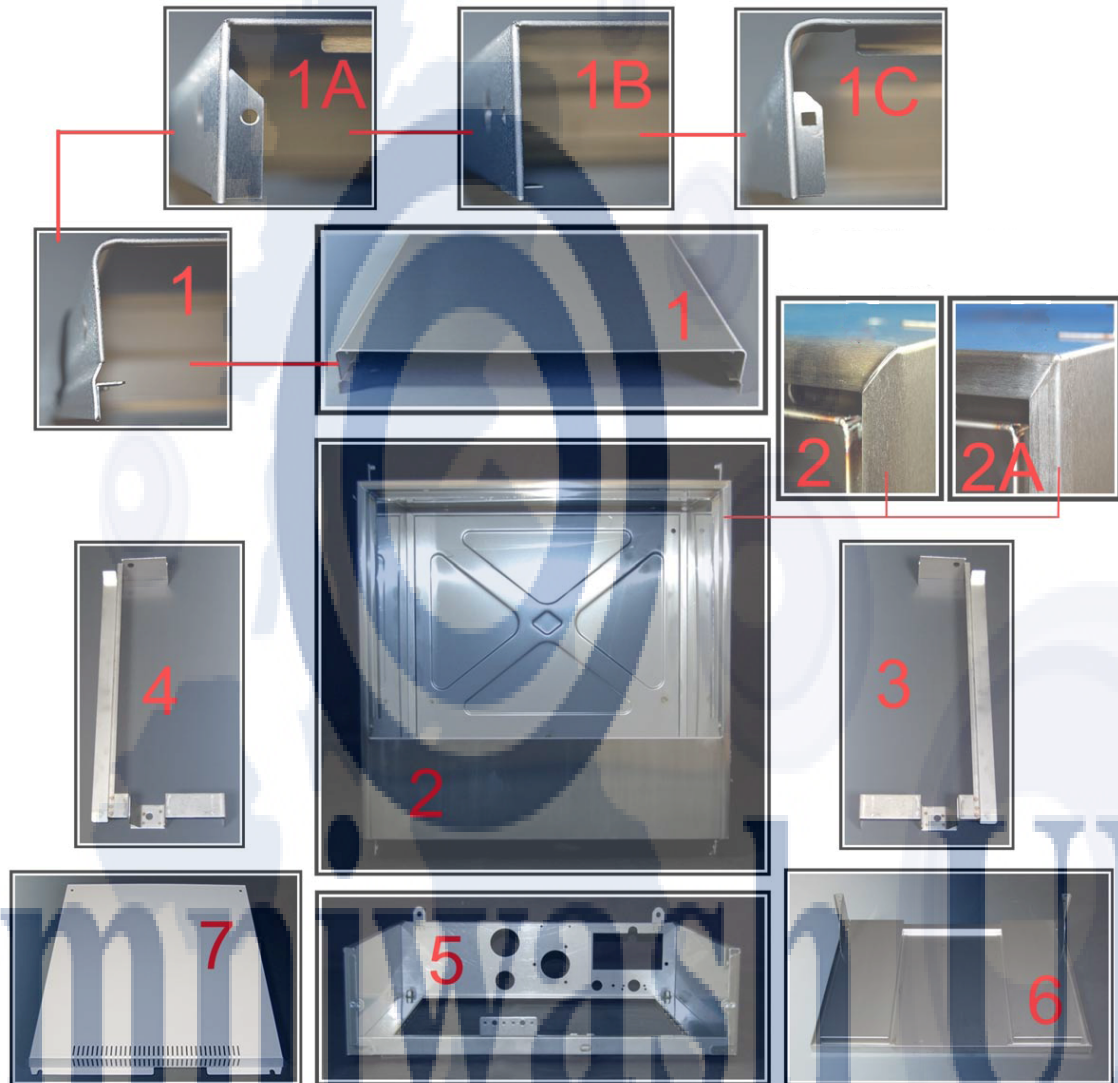

Item No.	Product Code	Description
1	GMPS5RDP	Top panel, steel
1A	GMPS5PR5	Top panel, steel
1B	GMPS5SIMPR5	Top panel, steel
1C	GMPS5N0S	Top panel, steel
2	GMVA5RPR5	Wash cabinet
2A	GMVA5PR5	Wash cabinet
3	GMGC5DXINT	Basket ramp, RH
4	GMGC5SXINT	Basket ramp, LH
5	GMBA5PR5	Base
6	GMP05PR5	Door
7	GMPP5PR5	Back panel

This guide is for informational purposes only. Omniwash UK makes no warranties or guarantees, express, implied or statutory, as to the information in this document.

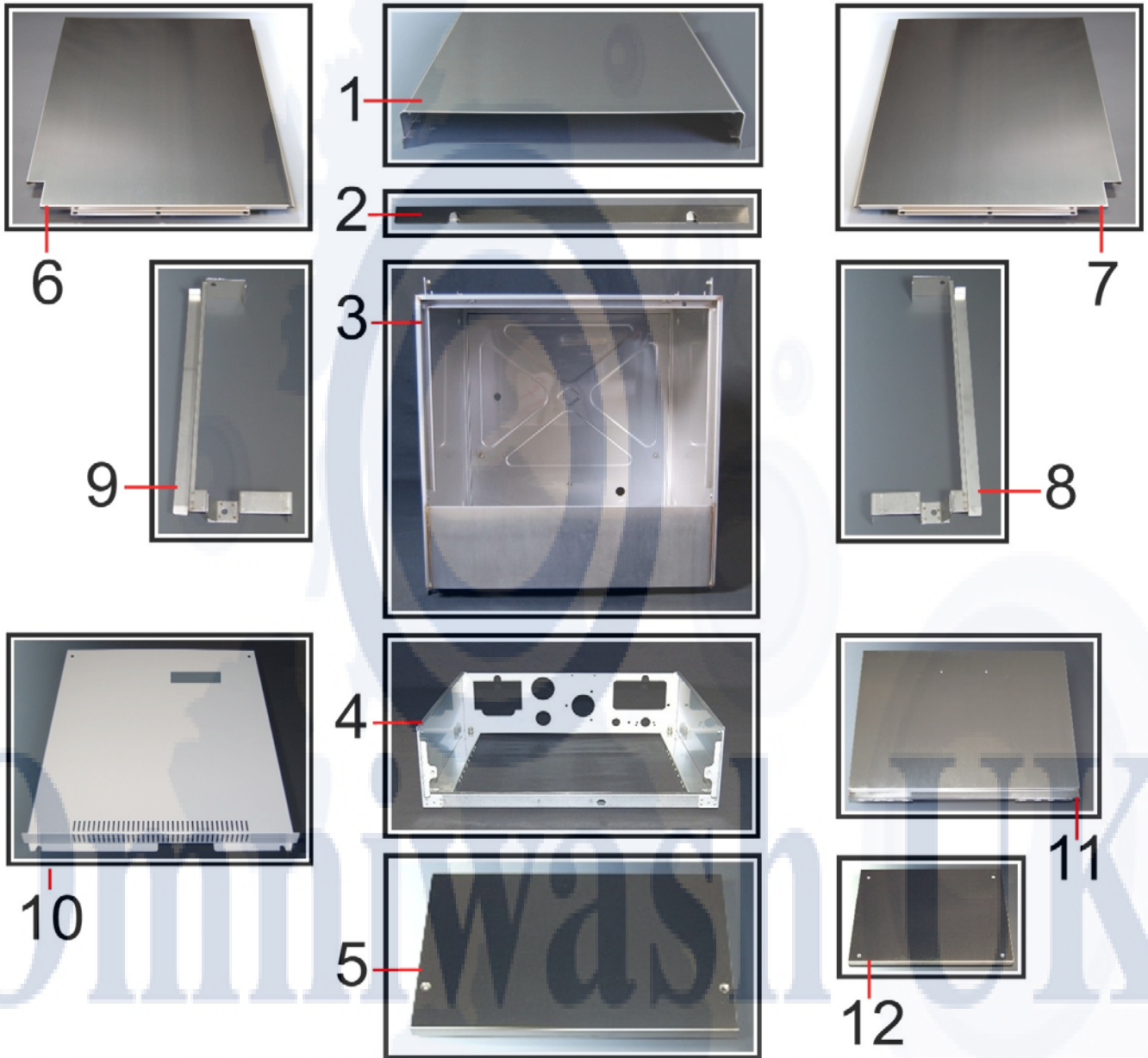

Item No.	Product Code	Description
1	GMPS5DP	Top panel
2	AMPV4DP	U section, cabinet
3	GMVA5DSGB	Wash cabinet, ABS version
4	GMBA5DSGB	Base, ABS version
5	GMCR5DSGB	Front panel, ABS version
6	GMPL5SXDS	Side panel, LH
7	GMPL5DXDS	Side panel, RH
8	GMGC5DXIDS	Basket ramp, RH
9	GMGC5SXIDS	Basket ramp, LH
10	GMPP5DSGB	Back panel
11	GMP05MDP	Door
12	GMC0P05DP	Door inner

This guide is for informational purposes only. Omniwash UK makes no warranties or guarantees, express, implied or statutory, as to the information in this document.

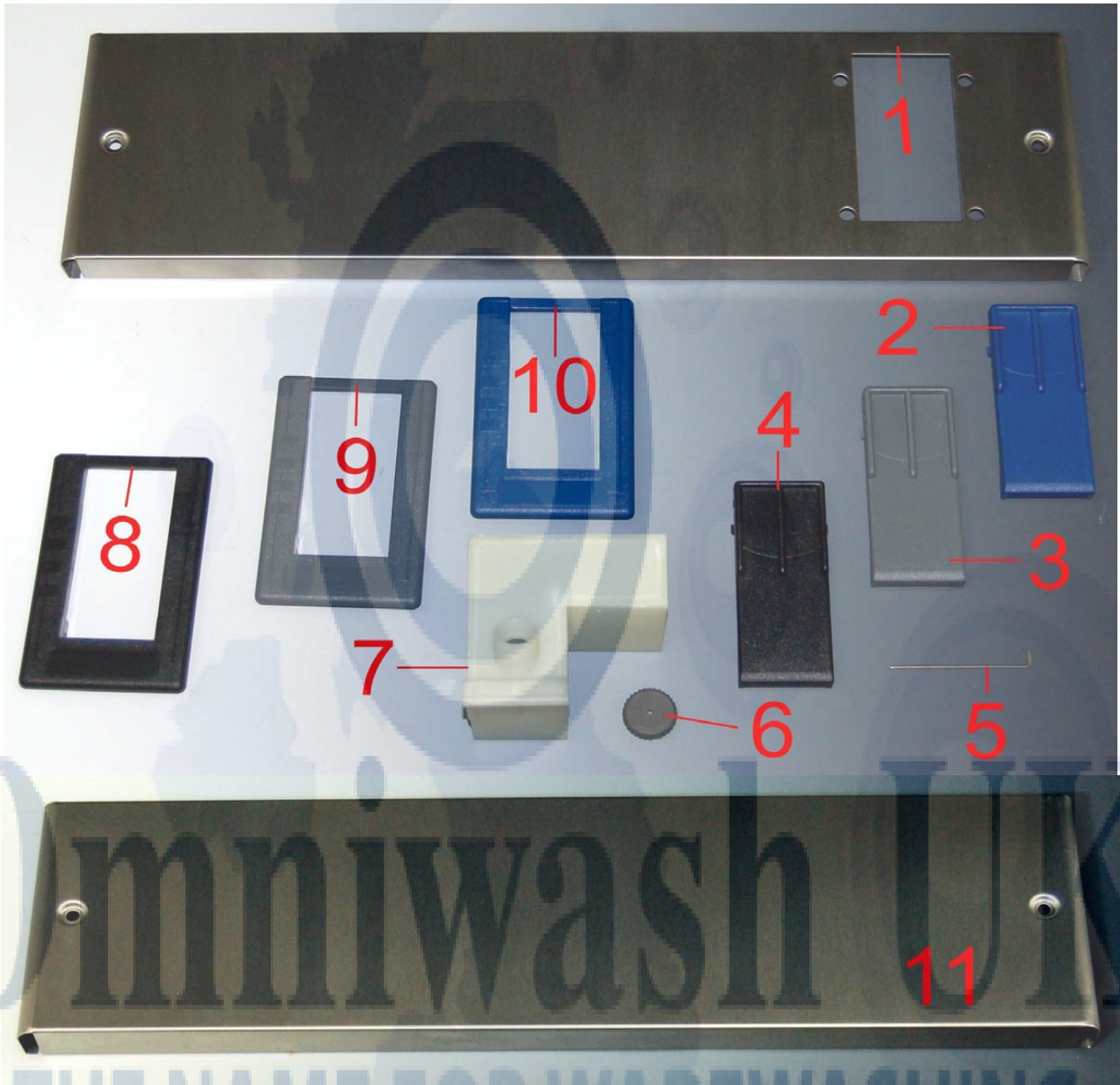

Item No.	Product Code	Description
1	GMCR5R	Bottom panel, with rinse aid aperture, steel
2	AM0TCBPLB	Rinse aid insert, plastic panel, blue
3	AM0TCBPLGR	Rinse aid insert, plastic panel, grey
4	AM0TCBPL	Rinse aid insert, plastic panel, black
5	AM029	Securing rod, rinse aid insert
6	AM030	Cap for rinse aid reservoir
7	AM027	Rinse aid resevoir
8	AM028N	Rinse aid insert, steel panel, black
9	AM028GR	Rinse aid insert, steel panel, grey
10	AM028BSIM	Rinse aid insert, steel panel, blue
11	GMCR5SCR	Bottom panel, plain, steel

This guide is for informational purposes only. Omniwash UK makes no warranties or guarantees, express, implied or statutory, as to the information in this document.



Item No.	Product Code	Description
1	GMCR5	Bottom panel, steel, with aperture
2	AM0TCBPLB	Plastic cover for rinse aid opening, blue
3	AM0TCBPLGR	Plastic cover for rinse aid opening, grey
4	AM0TCBPL	Plastic cover for rinse aid opening, black
5	AM029	Securing rod for rinse aid reservoir
6	AM030	Cap for rinse aid insert
7	AM027	Rinse aid reservoir
8	AM028N	Rinse aid reservoir frame, black
9	AM028GR	Rinse aid reservoir frame, grey
10	AM028BSIM	Rinse aid reservoir frame, blue
11	GMCR5SC	Bottom panel, steel, without aperture

This guide is for informational purposes only. Omniwash UK makes no warranties or guarantees, express, implied or statutory, as to the information in this document.

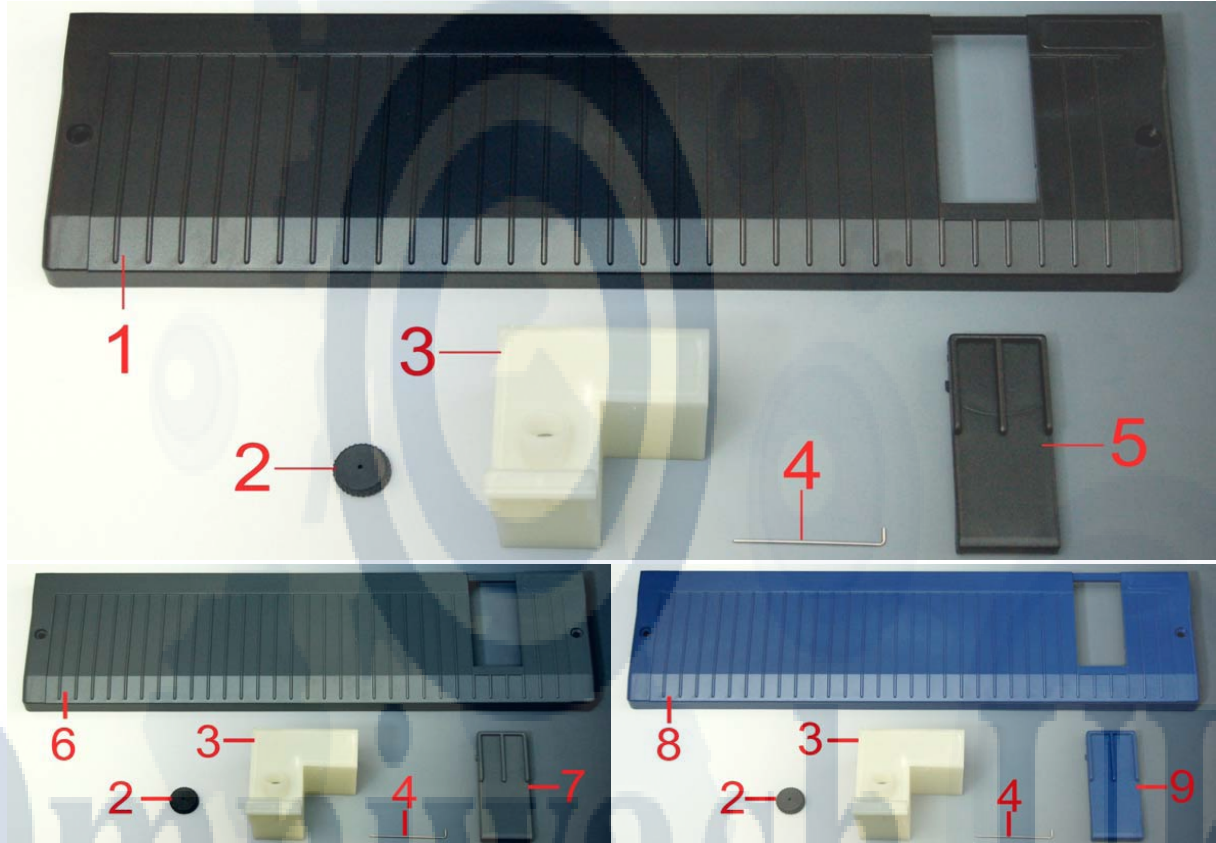

Item No.	Product Code	Description
1	GMCR5PL	Bottom panel, plastic, aperture, black
2	AM030	Cap for rinse aid reservoir
3	AM027	Rinse aid reservoir
4	AM029	Securing rod for rinse aid reservoir
5	AM0TCBPL	Plastic cover for rinse aid opening, black
6	GMCR5PLGR	Bottom panel, plastic, aperture, grey
7	AM0TCBPLGR	Plastic cover for rinse aid opening, grey
8	GMCR5PLBL	Bottom panel, plastic, aperture, blue
9	AM0TCBPLB	Plastic cover for rinse aid opening, blue



This guide is for informational purposes only. Omniwash UK makes no warranties or guarantees, express, implied or statutory, as to the information in this document.



Item No.	Product Code	Description
1	GMPS5GBPL	Top panel
2	GMPI4QC	Steel control panel
3	GMTI15GBPL	Rare frame steel control panel
4	AM010GB	Handle
5	GMC5GBPL	Bottom panel

This guide is for informational purposes only. Omniwash UK makes no warranties or guarantees, express, implied or statutory, as to the information in this document.

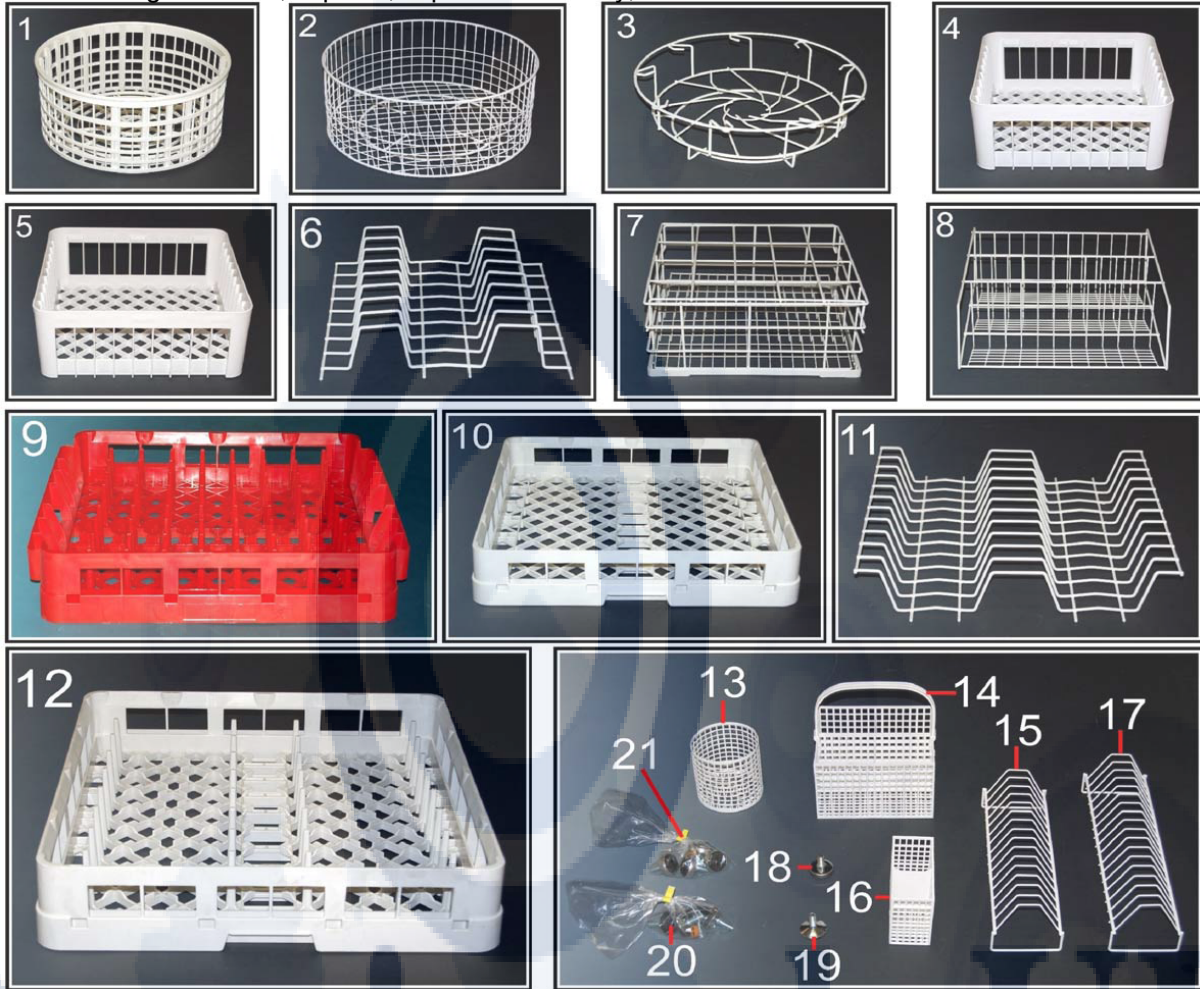

Item No.	Product Code	Description
1	CT3617PL2	Round basket plastic 36x17
2	CT4117L	Round basket wire 41x17
3	CT419P	Round rack wire 41 diameter - 9 plates
4	CQ3516LPL	Glass basket 35cm square plastic
5	CQ4016LPL	Glass basket 40cm square plastic
6	CQIP408P	Dish insert 400 square 8 plates
7	CQ4025B	Rack assembly tall glasses 40x18
8	CQIB403F	Rack base tall glasses 40x40
9	CQCV506PL	Tray rack 50x50
10	CQ50RPL	Glass rack 500 square
11	CQIP5022P	Dish insert 500 square 22 plates
12	CQ5018PPL	Dish rack 500 square
13	CTIP0S105	Circular cutlery basket diameter 105
14	IP4PM	Cutlery basket with handle
15	CTIP15	Small saucer rack
16	IP2PP	Small cutlery basket
17	CTIP17	Larger saucer rack
18	AM016NT	Adjustable foot - glasswashers
19	AM016	Adjustable foot - underc. dishwashers
20	AM016C	Set of 4 adjustable feet dishwashers
21	AM016NTC	Set of 4 adjustable feet glasswashers